

FR/ Annexe	ES/ Apéndice	PT/ Anexo	IT/ Appendice
EL/ Παράρτημα	PL/ Załącznik	RU/ Приложение	UK/ Додаток
RO/ Anexa	EN/ Appendix		

Ean code	**Model No.	size(mm)	profile
3276006002844	SH-SL160-W-F	1600x2000	white
3276006002806	SH-SL160-S-C	1600x2000	bright chrome
3276006002769	SH-SL140-W-F	1400x2000	white
3276006002721	SH-SL140-S-C	1400x2000	bright chrome
3276006002684	SH-SL120-W-F	1200x2000	white
3276006002646	SH-SL120-S-C	1200x2000	bright chrome
3276000231196	SH-SL180-W-F	1800x2000	white
3276000231165	SH-SL170-W-F	1700x2000	white
3276000231059	SH-SL120-S-F	1200x2000	bright chrome
3276000231042	SH-SL110-W-F	1100x2000	white
3276000231028	SH-SL110-S-C	1100x2000	bright chrome
3276000231127	SH-SL150-W-F	1500x2000	white
3276000231073	SH-SL130-S-F	1300x2000	bright chrome
3276000231004	SH-SL100-S-F	1000x2000	bright chrome
3276000231066	SH-SL130-S-C	1300x2000	bright chrome
3276000231011	SH-SL100-W-F	1000x2000	white
3276000230977	SH-SL100-S-C	1000x2000	bright chrome
3276000231097	SH-SL140-S-F	1400x2000	bright chrome
3276000231172	SH-SL180-S-C	1800x2000	bright chrome
3276000231134	SH-SL160-S-F	1600x2000	bright chrome
3276000231080	SH-SL130-W-F	1300x2000	white
3276000231189	SH-SL180-S-F	1800x2000	bright chrome
3276000231141	SH-SL170-S-C	1700x2000	bright chrome
3276000231103	SH-SL150-S-C	1500x2000	bright chrome
3276000231035	SH-SL110-S-F	1100x2000	bright chrome
3276000231158	SH-SL170-S-F	1700x2000	bright chrome
3276000231110	SH-SL150-S-F	1500x2000	bright chrome

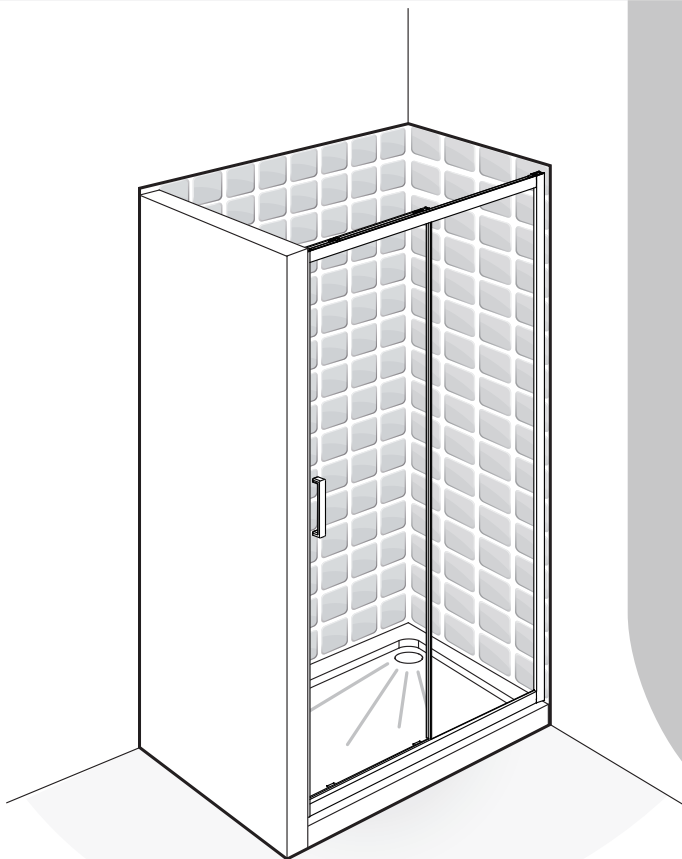

# CHARM



- FR** Notice de Montage, Utilisation, Entretien
- ES** Instrucciones de Montaje, Utilización y Mantenimiento
- PT** Instruções de Montagem, Utilização e Manutenção
- IT** Istruzioni per il Montaggio, l'Uso e la Manutenzione
- EL** Εγχειρίδιο συναρμολόγησης, χρήσης και συντήρησης
- PL** Instrukcja Montażu, Użytkowania i Konserwacji
- RU** Руководство По Сборке и Эксплуатации
- UK** Керівництво По Збірці і Експлуатації
- RO** Manual asamblare, utilizare și întreținere
- EN** Assembly - Use - Maintenance Manual

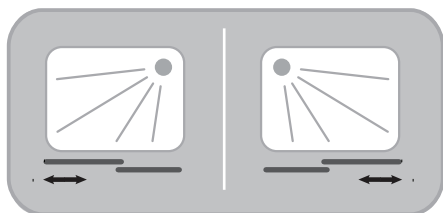

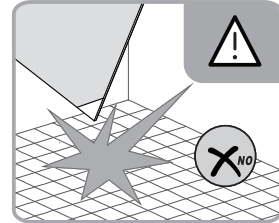
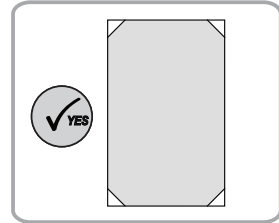
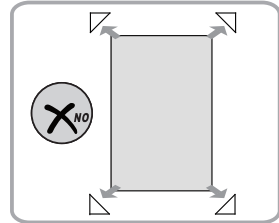
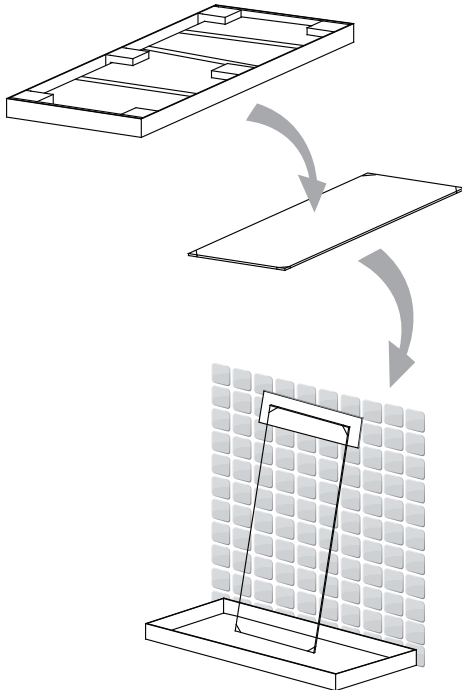
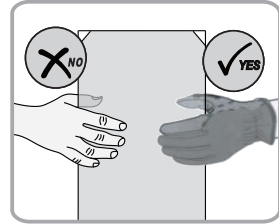
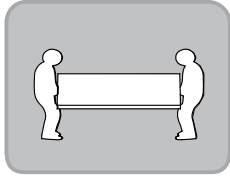
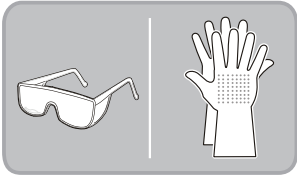
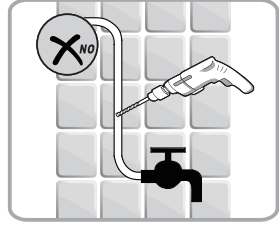
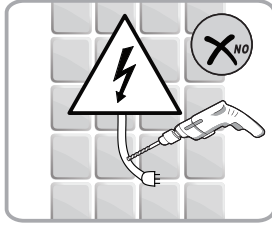
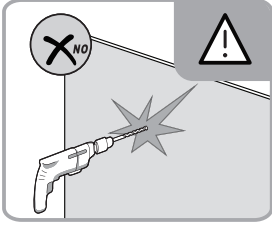

**FR** Vérifiez que les chevilles murales fournies sont appropriées à votre mur (celles fournies dans l'emballage sont conçues pour le béton). Sinon, utilisez des vis et des chevilles murales adaptées au type de matériau de votre mur. Pour obtenir des conseils concernant les vis et les chevilles appropriées à votre mur, demandez à un vendeur spécialisé.

**ES** Compruebe que todos los tacos suministrados puedan ser utilizados con su pared (los incluidos en la caja son para hormigón). En caso contrario, utilice tornillos y tacos de pared apropiados para el material de su pared. Para información acerca de las fijaciones y tornillos apropiados para su pared, consulte con un asistente de ventas especializado.

**PT** Certifique-se de que as buchas fornecidas são adequadas à sua parede (as fornecidas na embalagem são para betão). Caso contrário, use parafusos e buchas adequados ao tipo de material da sua parede. Para se aconselhar acerca dos parafusos e buchas adequados à sua parede, fale com um assistente de vendas especializado.

**IT** Verificare che i tasselli da parete forniti siano compatibili con la propria parete (quelli forniti con l'articolo sono per cemento). Altrimenti, utilizzare viti e tasselli adatti per la superficie della propria parete. Per ottenere consigli e suggerimenti sulle viti e i tasselli più adatti alla propria parete, consultare un rivenditore specializzato.

**EL** Βεβαιωθείτε ότι οι παρεχόμενες στερεώσεις τοίχου είναι κατάλληλες για τον τοίχο σας (οι παρεχόμενες στη συσκευή προορίζονται για μπετό). Αλλιώς χρησιμοποιήστε βίδες και στερεώσεις τοίχου κατάλληλες για τον τύπο υλικού του τοίχου σας. Για να λάβετε συμβουλές σχετικά με τις κατάλληλες βίδες και τα εξαρτήματα για τον τοίχο σας, ρωτήστε έναν ειδικό πωλητή.

**PL** Prosimy sprawdzić, czy dostarczone kołki do ścian nadają się do użycia w posiadanej ścianie (kołki dostarczone w zestawie są przeznaczone do betonu). Jeśli tak nie jest, należy użyć śrub i kołków odpowiednich do materiału, z którego wykonana jest ściana. Aby uzyskać poradę w sprawie śrub i elementów montażowych odpowiednich do danego typu ściany, należy zwrócić się z pytaniem do wyspecjalizowanego sprzedawcy.

**RU** Убедитесь, что прилагаемые дюбеля подходят для ваших стен (входящие в комплект дюбеля предназначены для бетона). В противном случае используйте шурупы и дюбеля, соответствующие материалу стены. Для получения рекомендаций по выбору шурупов и крепежных деталей, подходящих для вашей стены, обратитесь к специалисту-консультанту.

**UK** Перевірте, що анкери підходять для вашої стіни (ті, що постачаються в упаковці – для бетону). В іншому випадку використовуйте гвинти й стінові анкери, що відповідають матеріалу вашої стіни. Для отримання консультацій щодо гвинтів й фітінгів для вашої стіни зверніться до відповідного продавця-консультанта.

**RO** Verificați ca toate ancorele de perete furnizate să fie adecvate pentru peretele dumneavoastră (cele furnizate în pachet sunt pentru beton). În caz contrar, folosiți șuruburi și ancore de perete adecvate pentru tipul de material din care este peretele dumneavoastră. Pentru a obține recomandări privind șuruburile și armăturile adecvate pentru peretele dumneavoastră, întrebați un vânzător specializat.

**EN** Check that wall anchors provided are suitable for your wall (those provided in the package are for concrete). Otherwise, use screws and wall anchors suited to the type of material of your wall. To obtain advice on the screws and fittings suited to your wall, ask a specialized sales assistant.

2



**3M**

Assemble with this side, with easy clean treatment, on the inside.

İze karışı işleminde tabi tutulmuş bu yüzü iç tarafa doğru konumlanmalıdır.

Cette face, avec un traitement facilement nettoyable, doit être positionnée vers l'intérieur.

Esta cara está tratada para facilitar su limpieza y se debe colocar hacia el interior.

Esta face com tratamento para facilitar a limpeza, deve ficar voltada para o interior.

Questo lato, deve essere posizionato con il trattamento easy clean all'interno.

Эта сторона, обработанная средством против образования накипи, должна быть обращена вовнутрь.

Сторона, оброблена засобом проти накипу, повинна бути звернена всередину.

Această față, tratată pentru curățare ușoară, trebuie poziționată spre interior.

Strona z powłoką zapewniającą łatwe czyszczenie powinna być skierowana do wewnątrz.

Αυτή η όψη, με επεξεργασία για εύκολο καθαρισμό, πρέπει να τοποθετηθεί προς το εσωτερικό.

V.7 2014



Attention danger / Atención: Peligro / Atenção perigo / Attenzione pericolo / Προσοχή κίνδυνος /  
Uwaga niebezpieczeństwo / Внимание! Опасно! / Увага! Небезпечно! / Atenție, pericol / Caution danger



Correct / Correcto / Correcto / Corretto / Σωστό / Dobrze / Правильный /  
Правильно / Corect / Correct



Incorrect / Incorrecto / Incorrecto / Errato / Λάθος / Žle / Неправильный /  
Неправильно / Incorect / Incorrect

**Notes / Observaciones / Notas / Note / Σημειώσεις / Notatki / Примечания / Примітки / Note / Notes**

---

---

---

---

---

---

---

FR Préparation

ES Preparación

PT Preparação

IT Preparazione

EL Προετοιμασία

PL Przygotowanie

RU Подготовка

UK Підготування

RO Pregătire

EN Preparation

A

2h

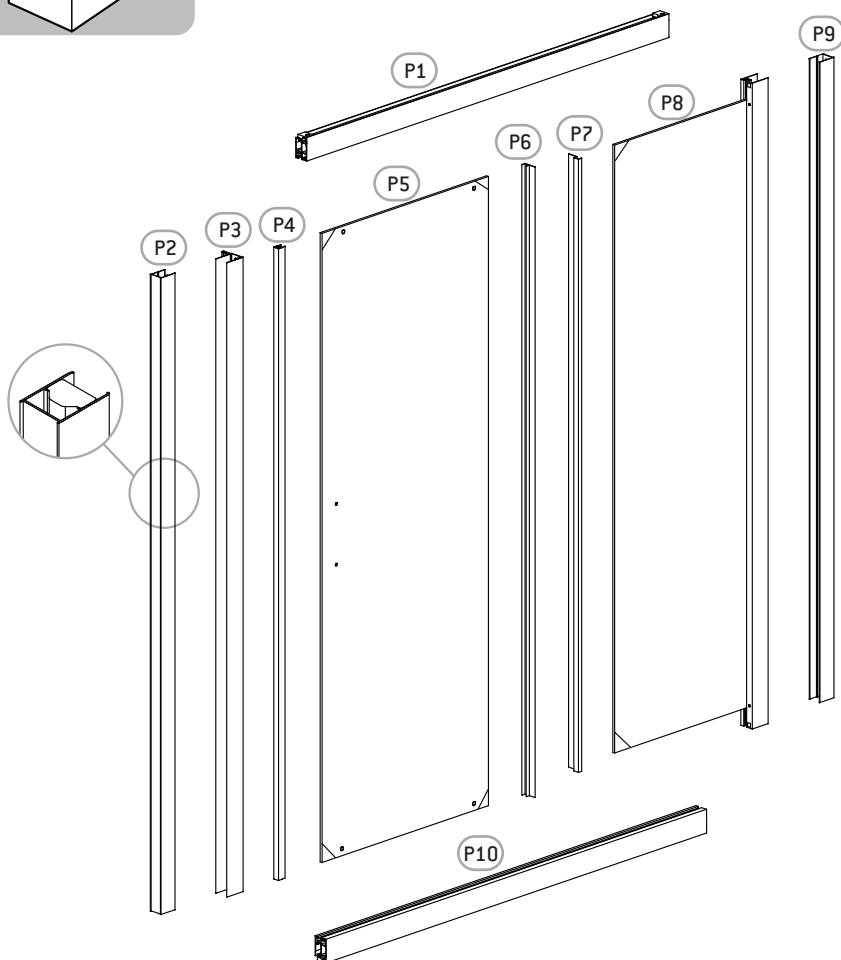
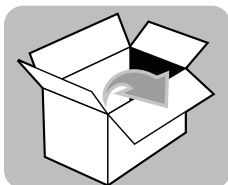

# A

FR Préparation

ES Preparación

PT Preparação

IT Preparazione

EL Προετοιμασία

PL Przygotowanie

RU Подготовка

UK Підготування

RO Pregătire

EN Preparation

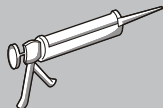
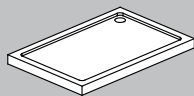
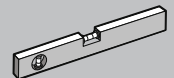
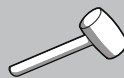
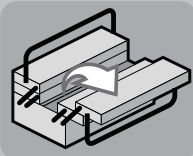
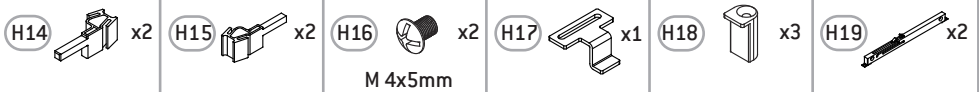
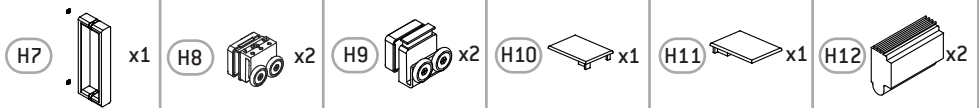
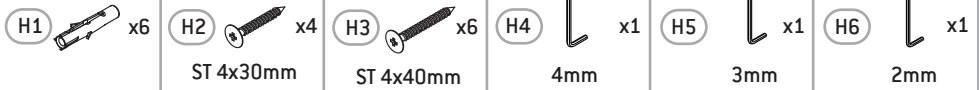
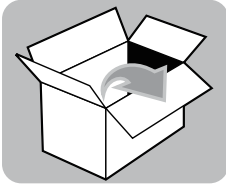

FR Montage

ES Montaje

PT Montagem

IT Montaggio

EL Συναρμολόγηση

PL Montaż

RU Сборка

UK Збірка

RO Montaj

EN Assembly

B

1

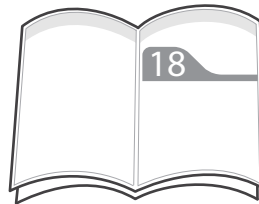
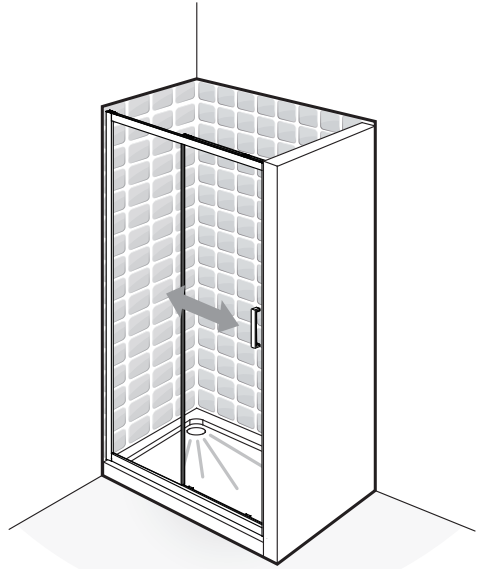
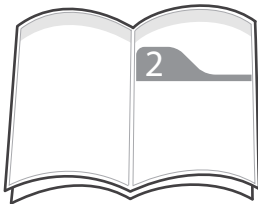
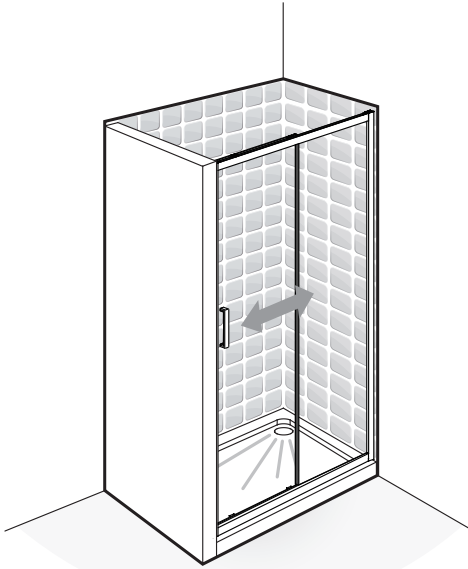



**B**

FR Montage

ES Montaje

PT Montagem

IT Montaggio

EL Συναρμολόγηση

PL Montaż

RU Сборка

UK Збірка

RO Montaj

EN Assembly

2

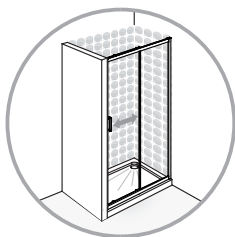

1

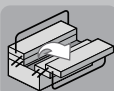
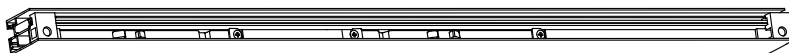
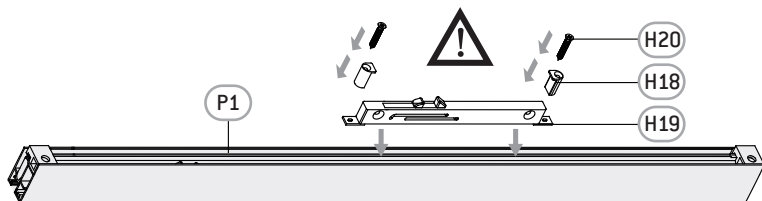
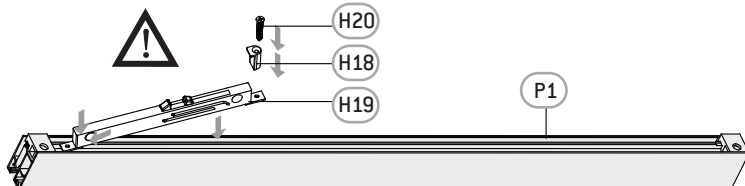

⊕ PH2

P1



x1

H18



x3

H19



x2

H20



x3

ST 3.5x30mm



FR Montage

ES Montaje

PT Montagem

IT Montaggio

EL Συναρμολόγηση

PL Montaż

RU Сборка

UK Збірка

RO Montaj

EN Assembly

B

3

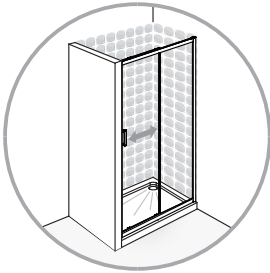

1

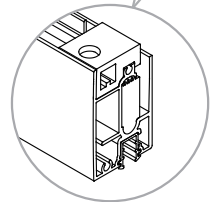
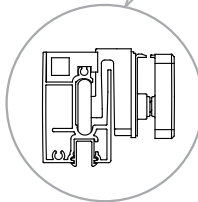

P1



x1

H8



x2

H12



x1



**B**

FR Montage

ES Montaje

PT Montagem

IT Montaggio

EL Συναρμολόγηση

PL Montaż

RU Сборка

UK Збірка

RO Montaj

EN Assembly

4

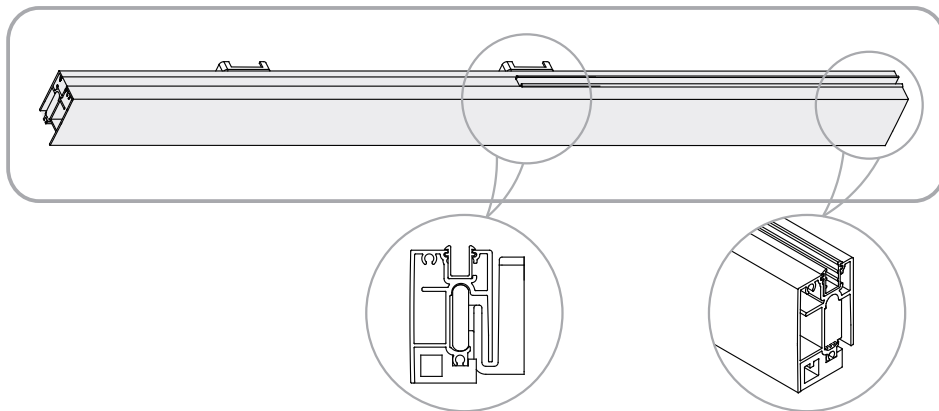
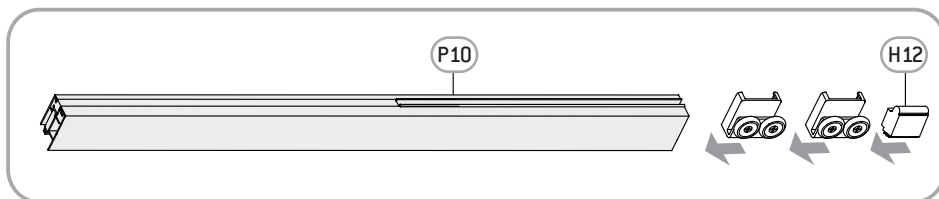
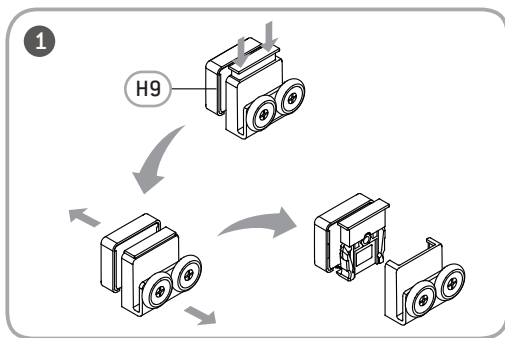
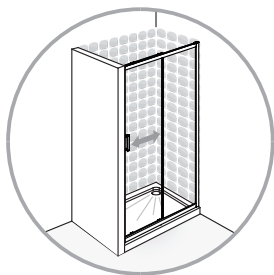

P10



x1

H9



x2

H12



x1



FR Montage

ES Montaje

PT Montagem

IT Montaggio

EL Συναρμολόγηση

PL Montaż

RU Сборка

UK Збірка

RO Montaj

EN Assembly

B

5

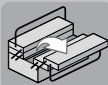
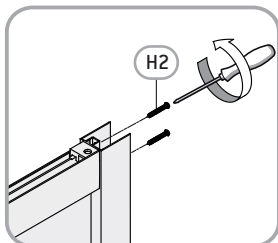
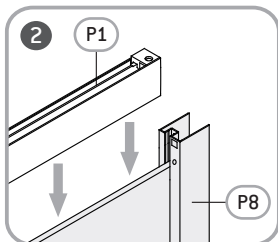
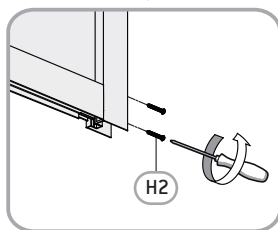
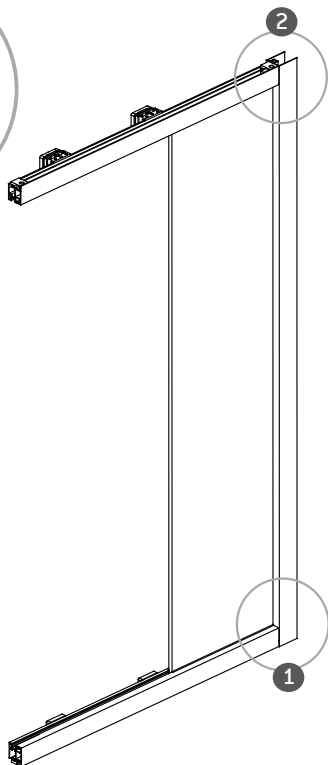
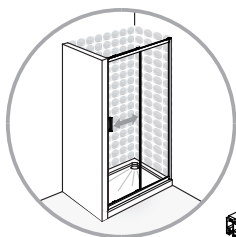
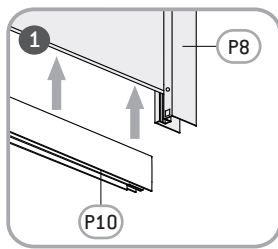
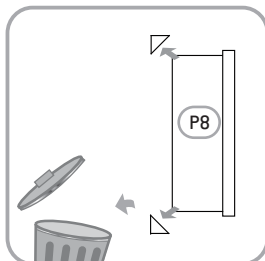

PH2

P1 x1

P10 x1

P8 x1

H2 x4

ST 4x30mm



**B**

FR Montage

ES Montaje

PT Montagem

IT Montaggio

EL Συναρμολόγηση

PL Montaż

RU Сборка

UK Збірка

RO Montaj

EN Assembly

6

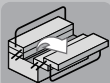
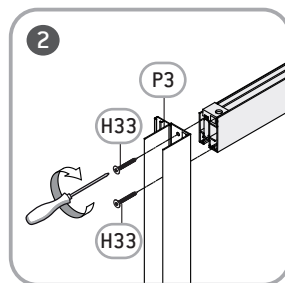
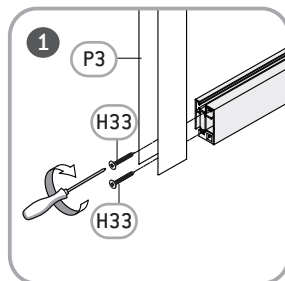
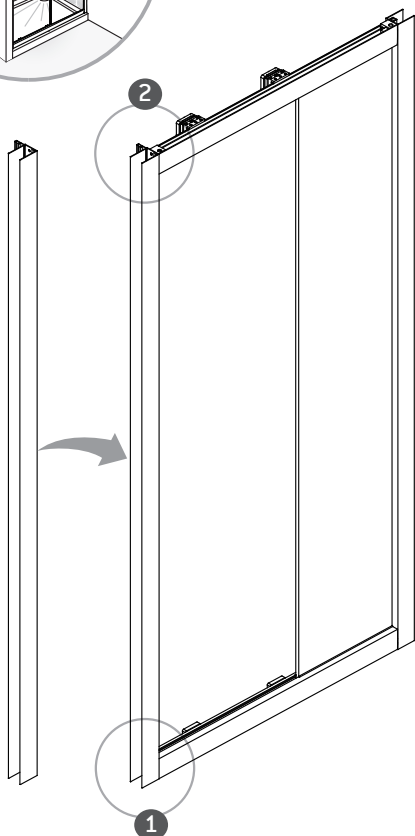
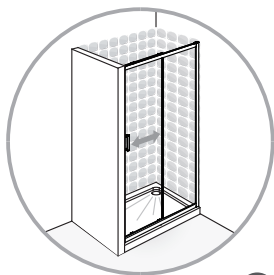

⊕ PH2

P3

x1

H33

x4

ST 4x20mm



FR Montage

ES Montaje

PT Montagem

IT Montaggio

EL Συναρμολόγηση

PL Montaż

RU Сборка

UK Збірка

RO Montaj

EN Assembly

B

7

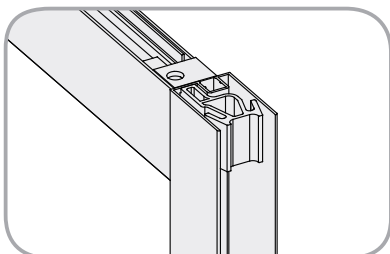
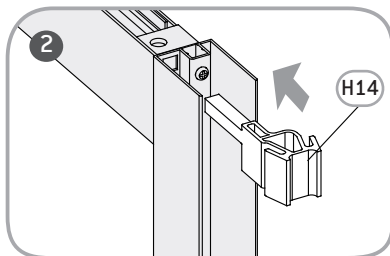
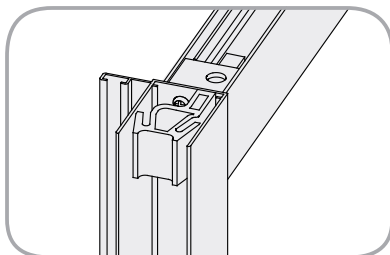
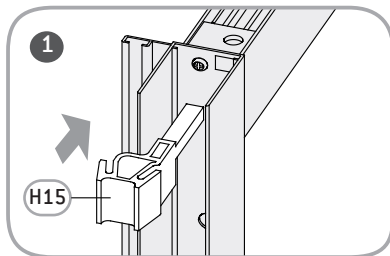
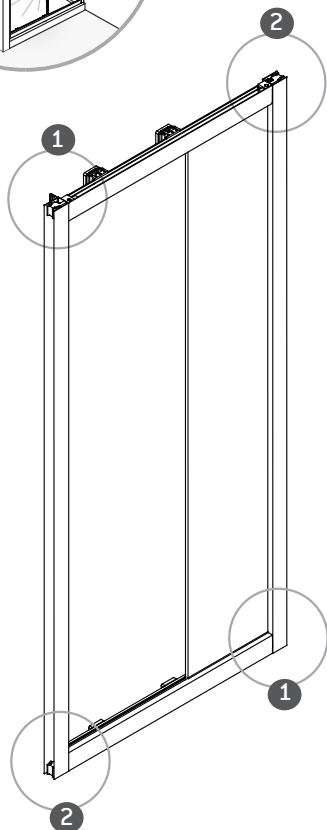
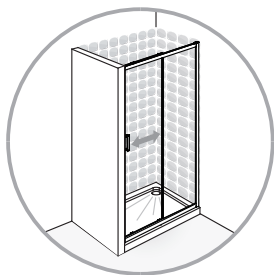

H14



x2

H15



x2



**B**

FR Montage

ES Montaje

PT Montagem

IT Montaggio

EL Συναρμολόγηση

PL Montaż

RU Сборка

UK Збірка

RO Montaj

EN Assembly

8

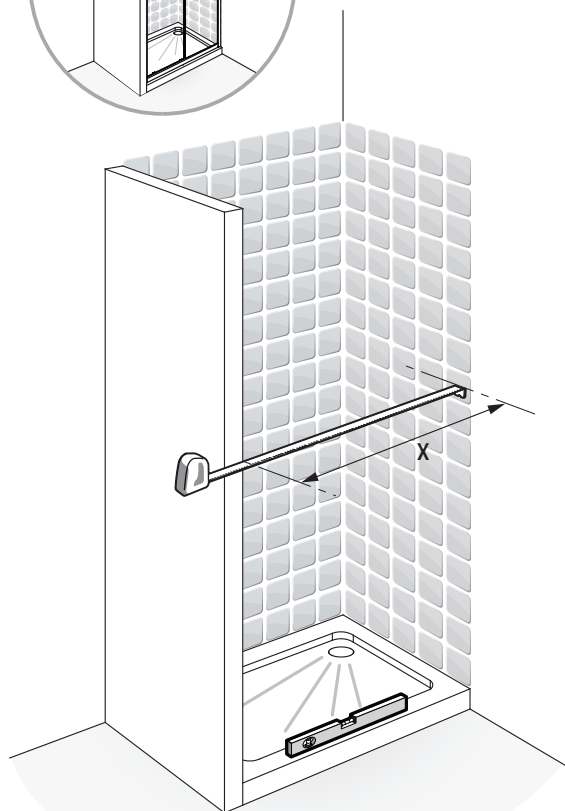
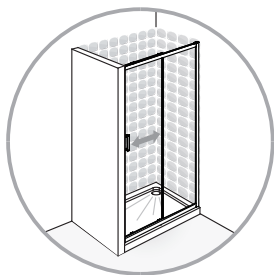

CHARM	X(mm)
1000mm	970-1010
1100mm	1070-1110
1200mm	1170-1210
1300mm	1270-1310
1400mm	1370-1410
1500mm	1470-1510
1600mm	1570-1610
1700mm	1670-1710
1800mm	1770-1810

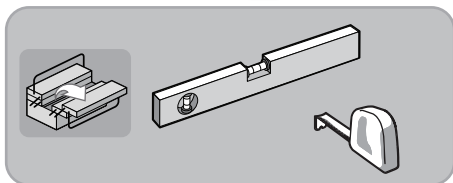
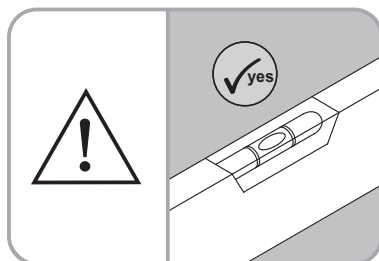

FR Montage

ES Montaje

PT Montagem

IT Montaggio

EL Συναρμολόγηση

PL Montaż

RU Сборка

UK Збірка

RO Montaj

EN Assembly

B

9

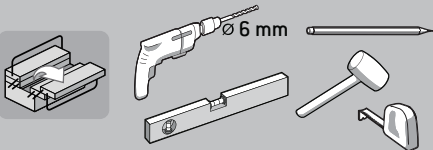
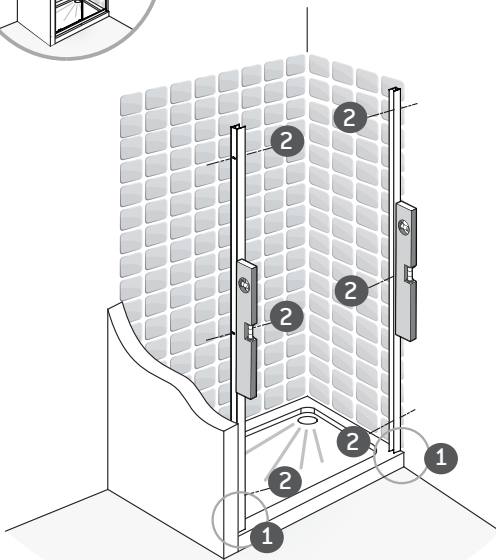
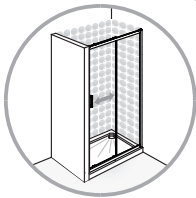
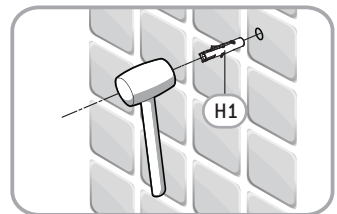
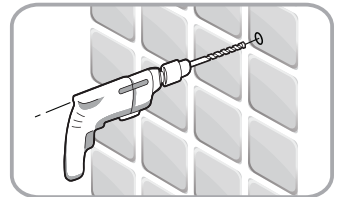
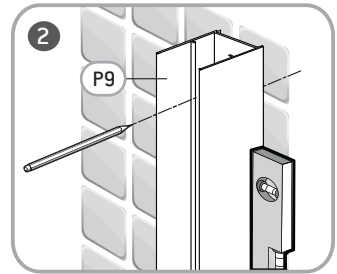
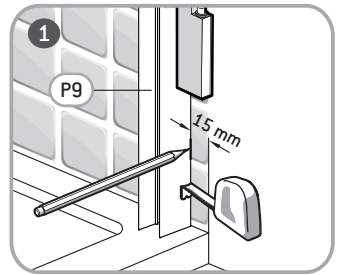
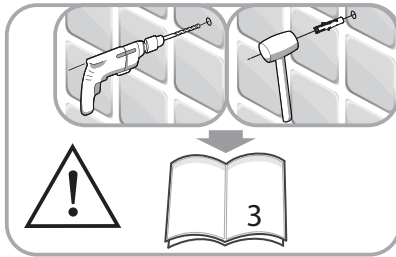



**B**

FR Montage

ES Montaje

PT Montagem

IT Montaggio

EL Συναρμολόγηση

PL Montaż

RU Сборка

UK Збірка

RO Montaj

EN Assembly

10

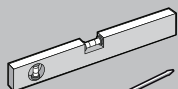
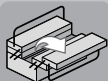
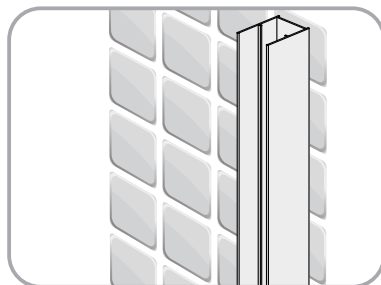
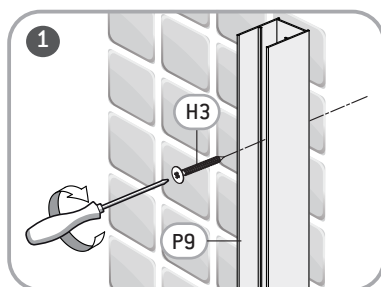
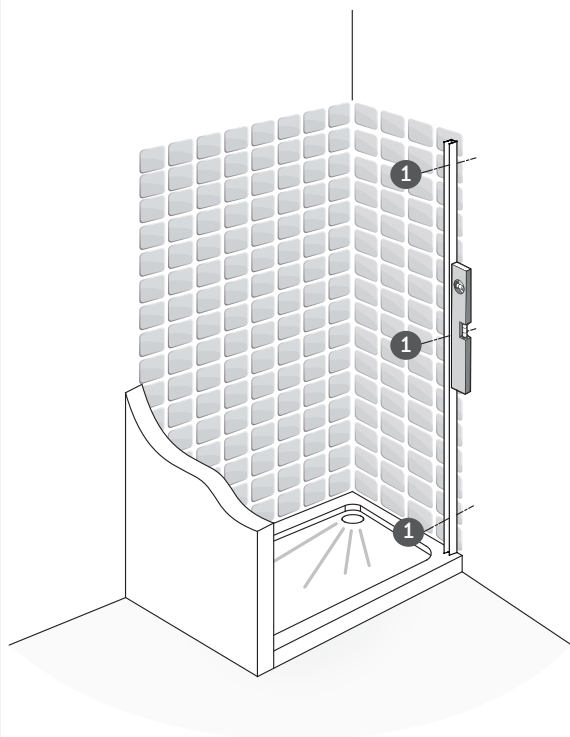
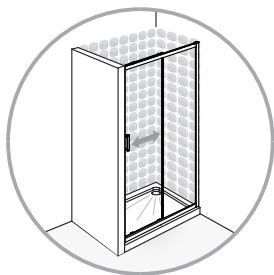

H3  x3  
ST 4x40mm

P9  x1



FR Montage

ES Montaje

PT Montagem

IT Montaggio

EL Συναρμολόγηση

PL Montaż

RU Сборка

UK Збірка

RO Montaj

EN Assembly

B

11

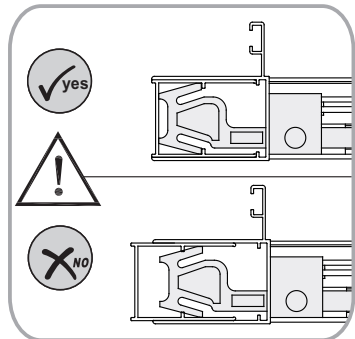
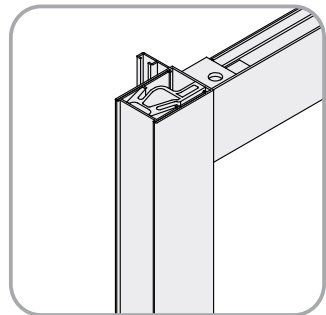
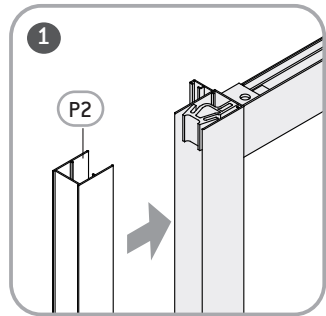
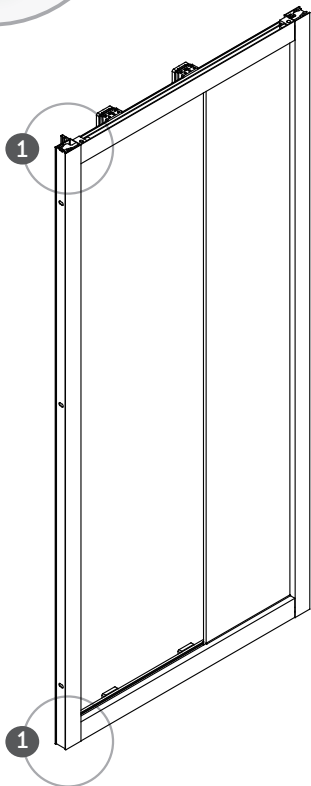
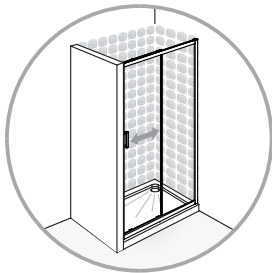

P2

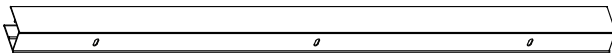

x1



**B**

FR Montage

ES Montaje

PT Montagem

IT Montaggio

EL Συναρμολόγηση

PL Montaż

RU Сборка

UK Збірка

RO Montaj

EN Assembly

12

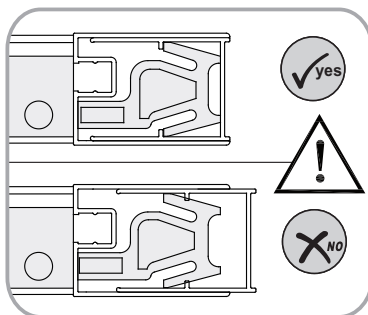
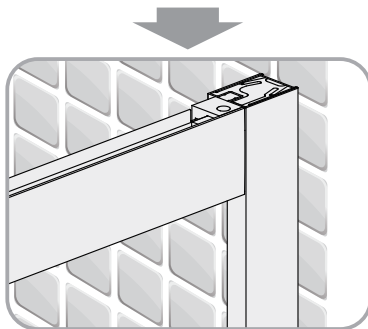
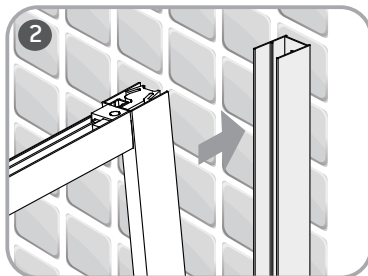
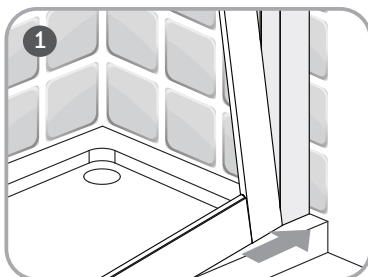
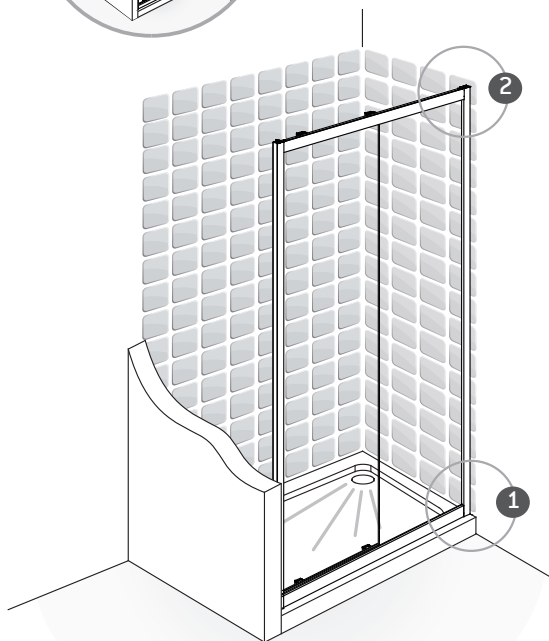
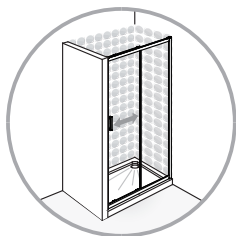
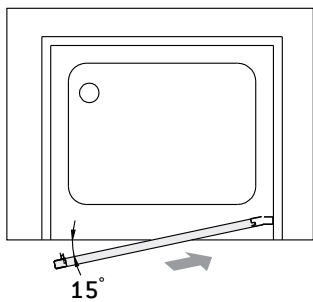

FR Montage

ES Montaje

PT Montagem

IT Montaggio

EL Συναρμολόγηση

PL Montaż

RU Сборка

UK Збірка

RO Montaj

EN Assembly

B

13

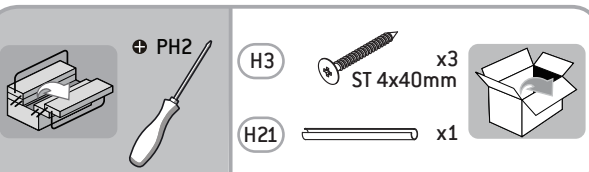
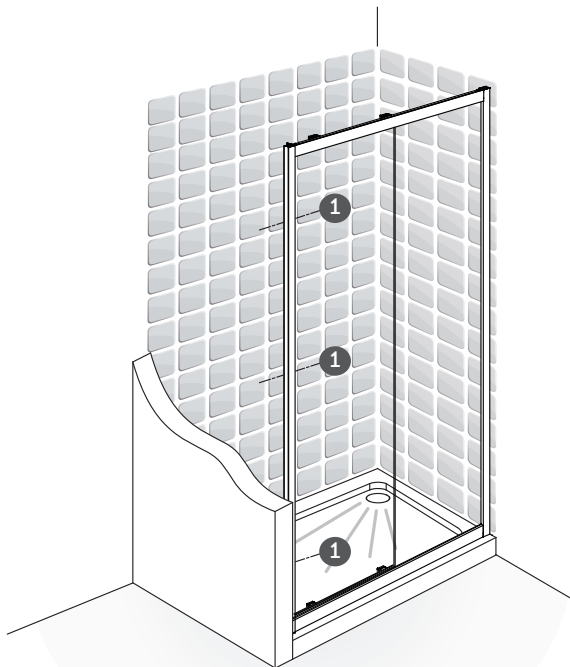
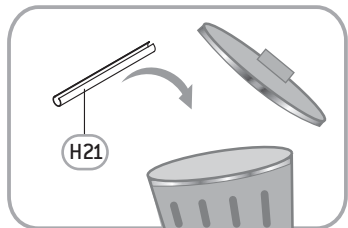
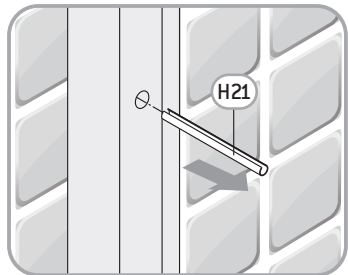
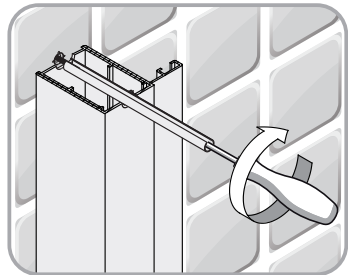
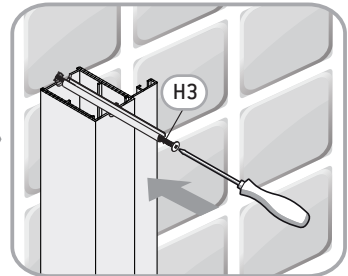
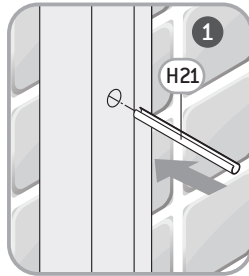
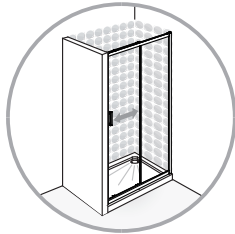

**B**

FR Montage

ES Montaje

PT Montagem

IT Montaggio

EL Συναρμολόγηση

PL Montaż

RU Сборка

UK Збірка

RO Montaj

EN Assembly

14

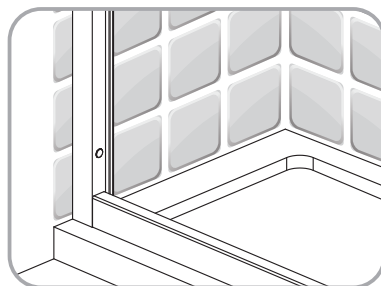
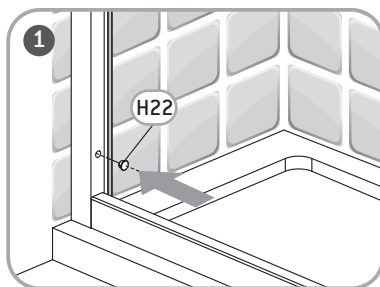
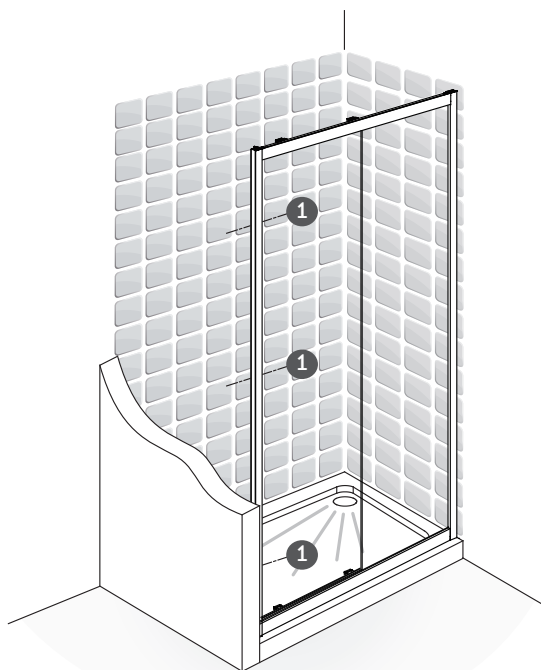
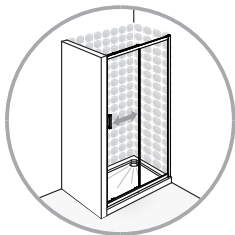

H22



x3



FR Montage

ES Montaje

PT Montagem

IT Montaggio

EL Συναρμολόγηση

PL Montaż

RU Сборка

UK Збірка

RO Montaj

EN Assembly

B

15

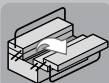
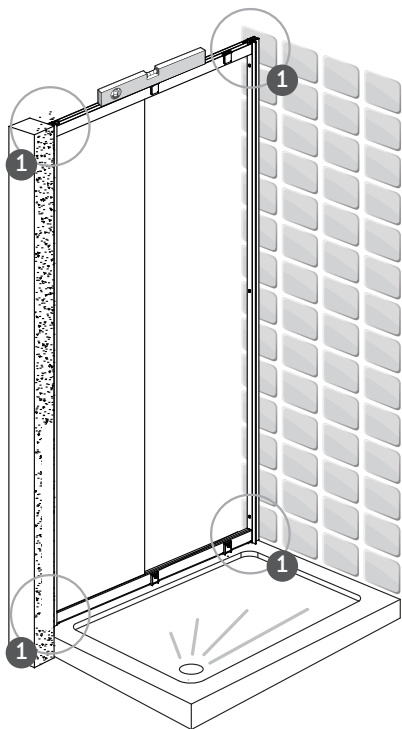
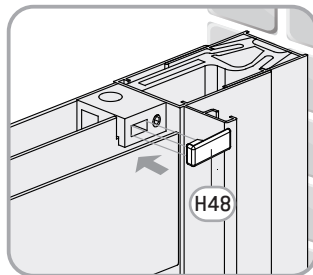
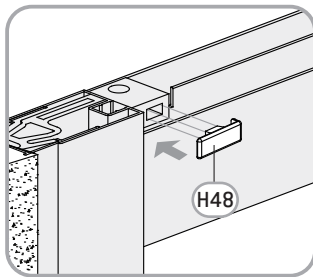
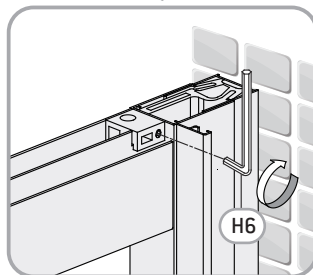
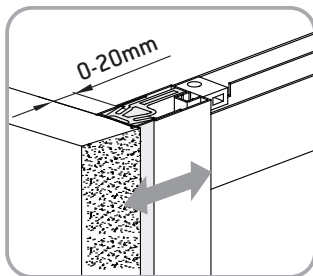
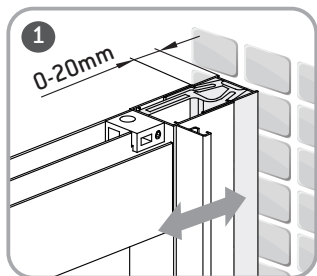
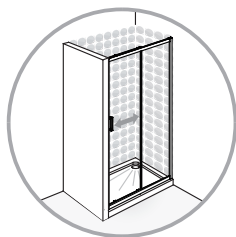

H6



x1

H48



x2



**B**

FR Montage

ES Montaje

PT Montagem

IT Montaggio

EL Συναρμολόγηση

PL Montaż

RU Сборка

UK Збірка

RO Montaj

EN Assembly

16

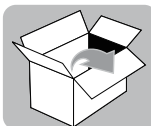
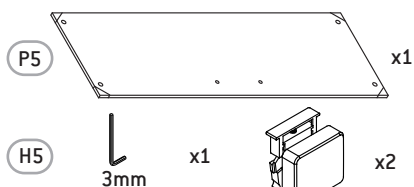
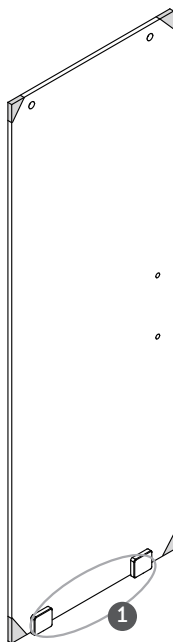
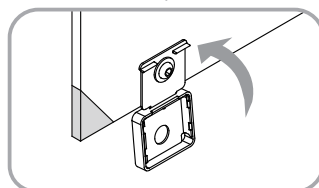
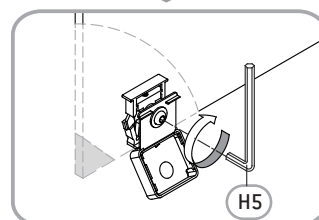
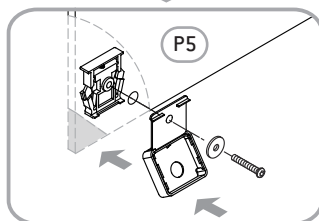
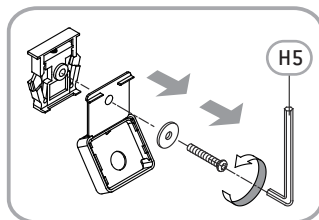
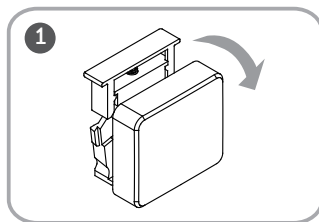
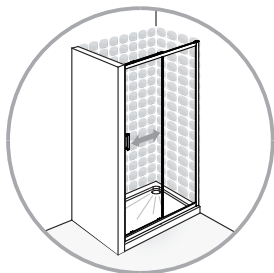

FR Montage

ES Montaje

PT Montagem

IT Montaggio

EL Συναρμολόγηση

PL Montaż

RU Сборка

UK Збірка

RO Montaj

EN Assembly

B

17

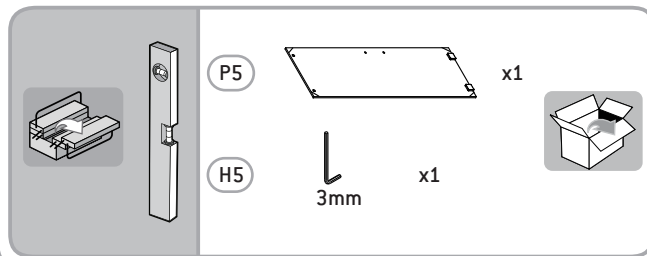
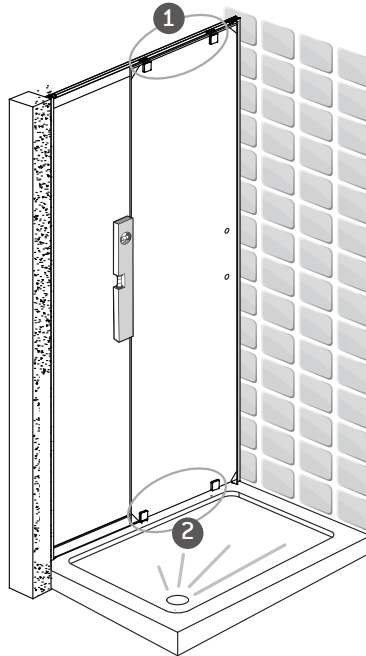
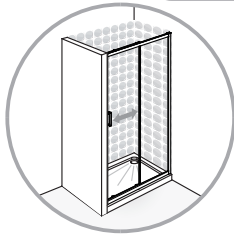
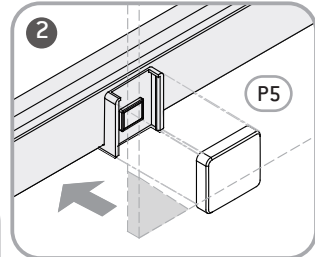
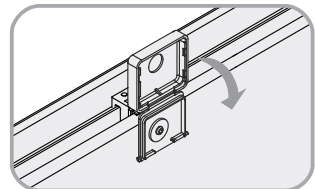
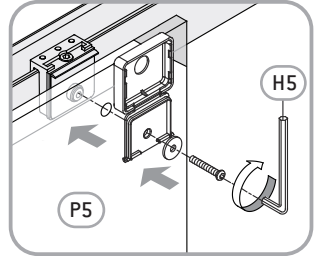
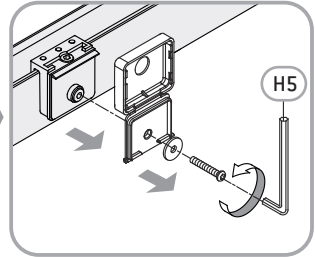
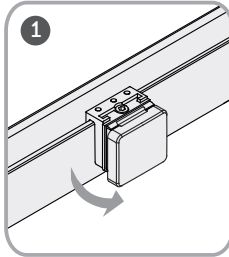



**B**

FR Montage

ES Montaje

PT Montagem

IT Montaggio

EL Συναρμολόγηση

PL Montaż

RU Сборка

UK Збірка

RO Montaj

EN Assembly

18

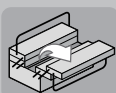
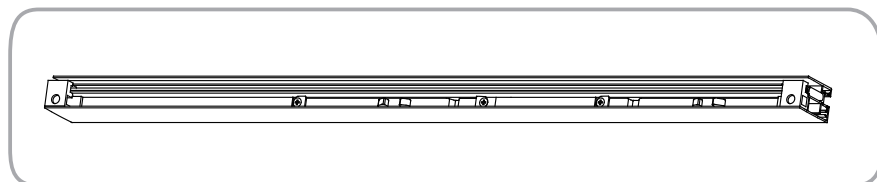
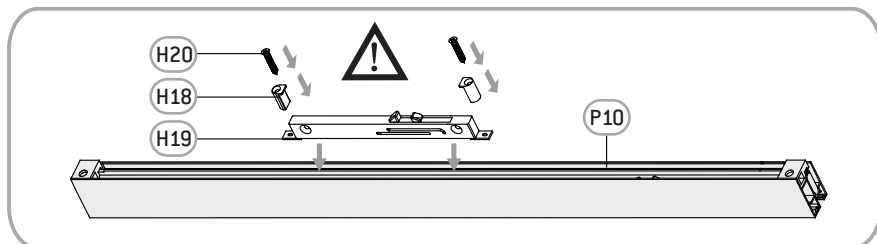
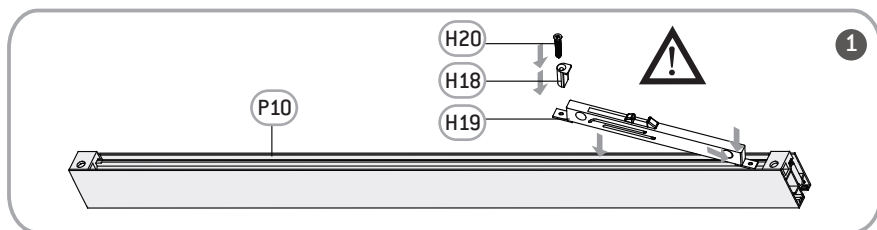
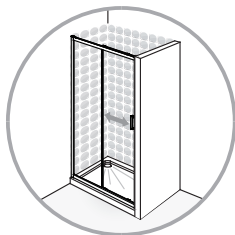

+ PH2



P10



x1

H18



x3

H19



x2

H20



x3

ST 3.5x30mm



FR Montage

ES Montaje

PT Montagem

IT Montaggio

EL Συναρμολόγηση

PL Montaż

RU Сборка

UK Збірка

RO Montaj

EN Assembly

B

19

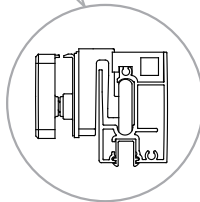
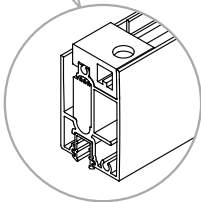
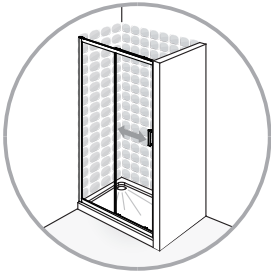

P10



x1

H8



x2

H12



x1



**B****FR** Montage**ES** Montaje**PT** Montagem**IT** Montaggio**EL** Συναρμολόγηση**PL** Montaż**RU** Сборка**UK** Збірка**RO** Montaj**EN** Assembly

20

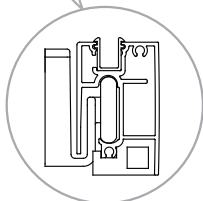
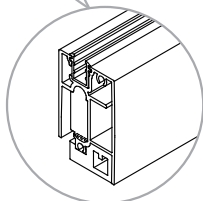
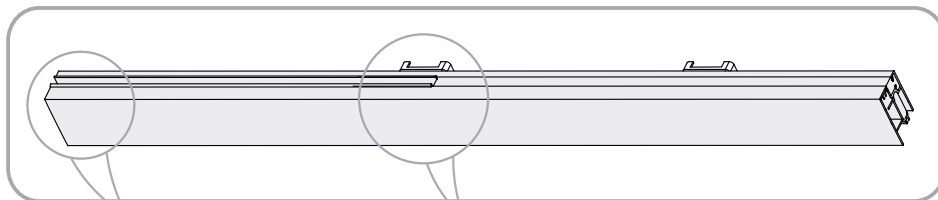
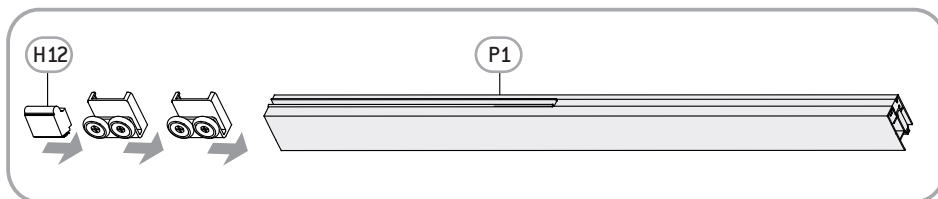
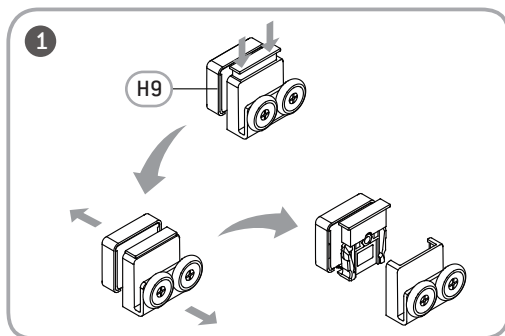
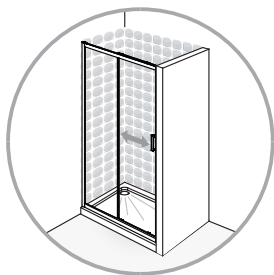

P1



x1

H9



x2

H12



x1



FR Montage

ES Montaje

PT Montagem

IT Montaggio

EL Συναρμολόγηση

PL Montaż

RU Сборка

UK Збірка

RO Montaj

EN Assembly

B

21

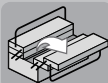
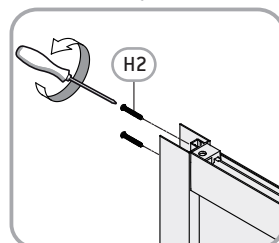
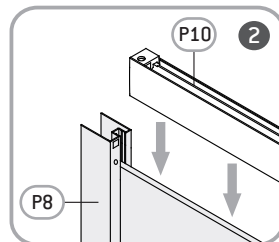
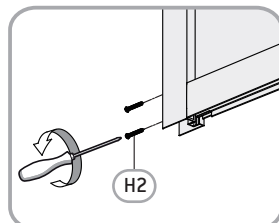
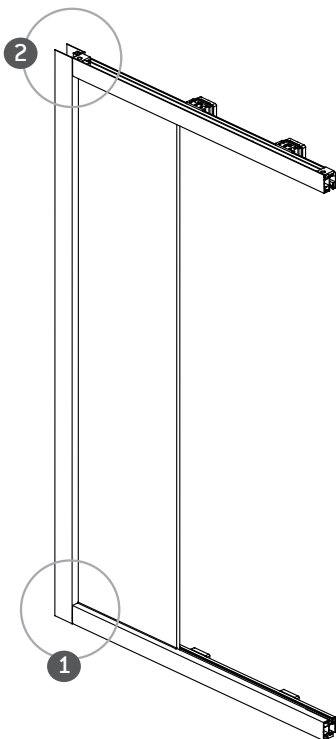
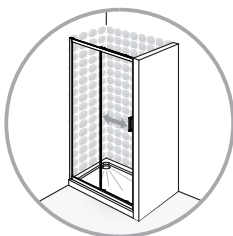
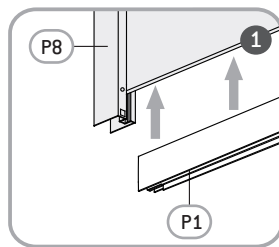
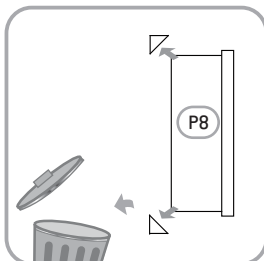

PH2

P10 x1

P1 x1

P8 x1

H2



x4

ST 4x30mm



**B**

FR Montage

ES Montaje

PT Montagem

IT Montaggio

EL Συναρμολόγηση

PL Montaż

RU Сборка

UK Збірка

RO Montaj

EN Assembly

22

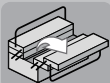
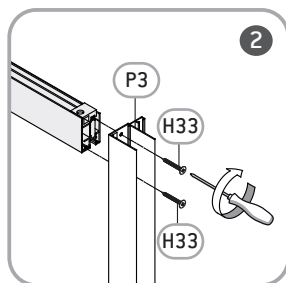
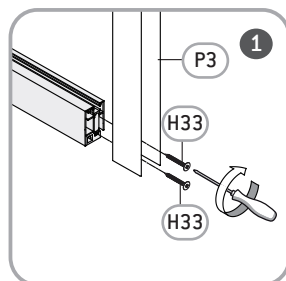
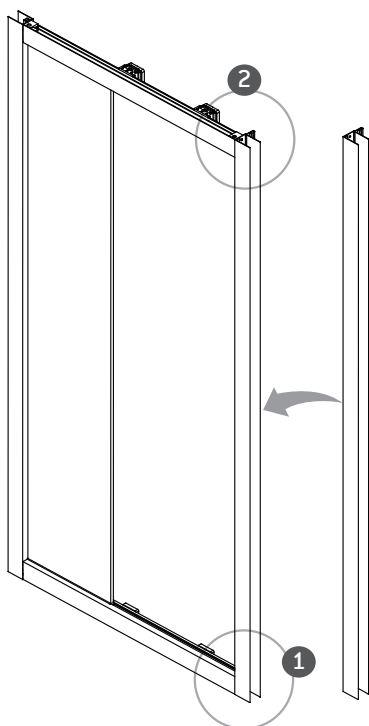
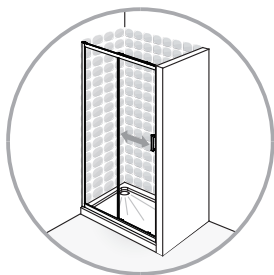

⊕ PH2

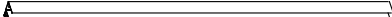
P3  x1H33  x4

ST 4x20mm



FR Montage

ES Montaje

PT Montagem

IT Montaggio

EL Συναρμολόγηση

PL Montaż

RU Сборка

UK Збірка

RO Montaj

EN Assembly

B

23

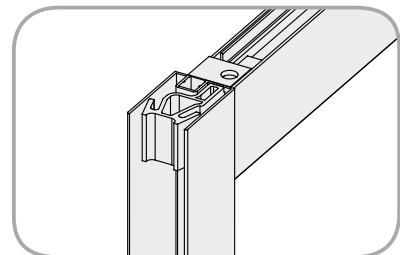
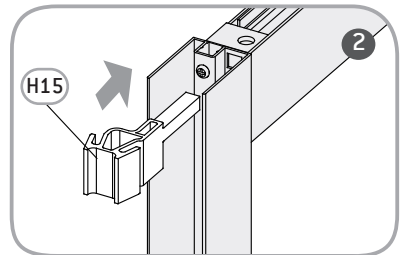
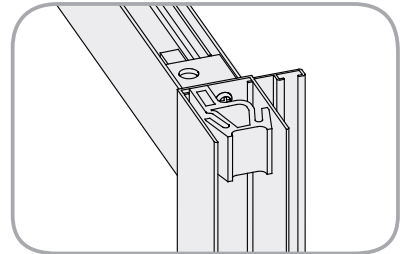
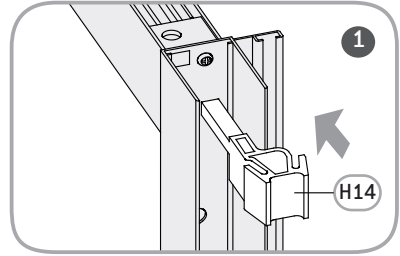
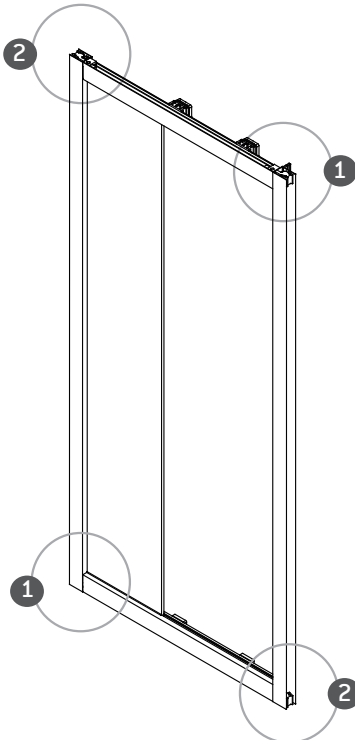
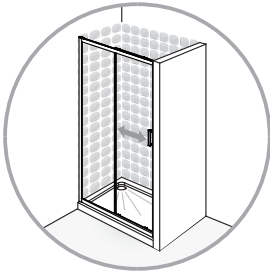

H14



x2

H15



x2



**B**

FR Montage

ES Montaje

PT Montagem

IT Montaggio

EL Συναρμολόγηση

PL Montaż

RU Сборка

UK Збірка

RO Montaj

EN Assembly

24

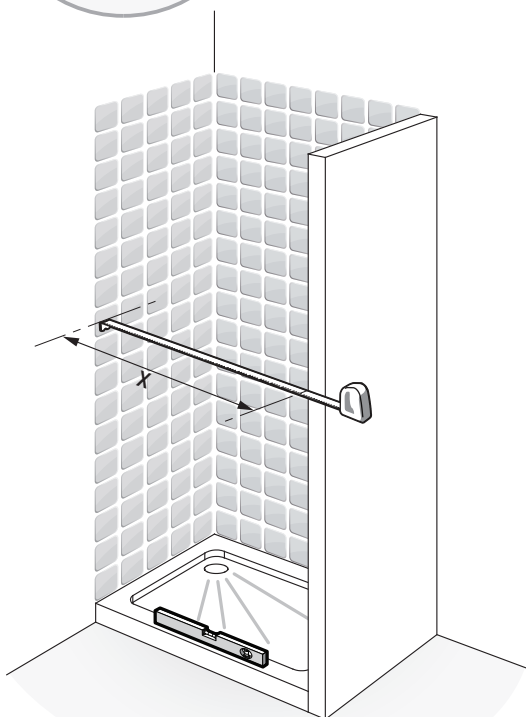
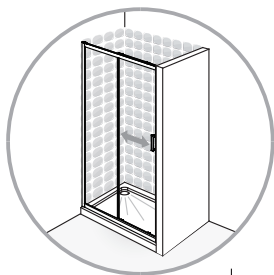

CHARM	X(mm)
1000mm	970-1010
1100mm	1070-1110
1200mm	1170-1210
1300mm	1270-1310
1400mm	1370-1410
1500mm	1470-1510
1600mm	1570-1610
1700mm	1670-1710
1800mm	1770-1810

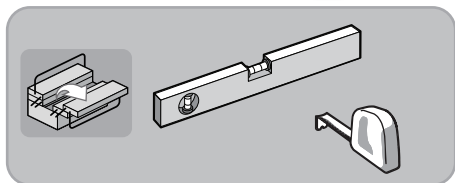
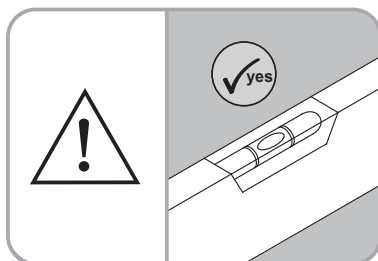

FR Montage

ES Montaje

PT Montagem

IT Montaggio

EL Συναρμολόγηση

PL Montaż

RU Сборка

UK Збірка

RO Montaj

EN Assembly

B

25

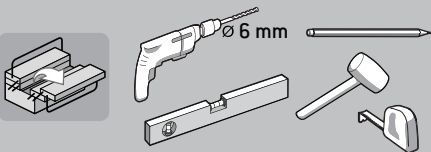
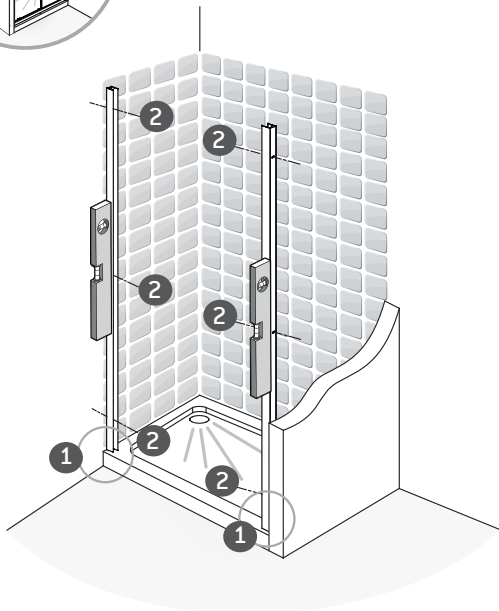
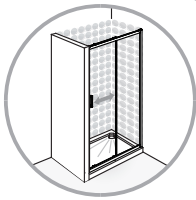
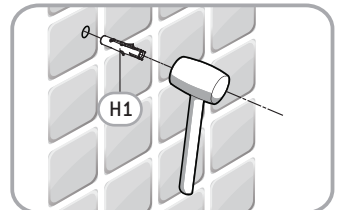
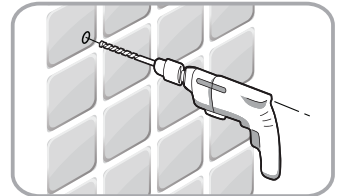
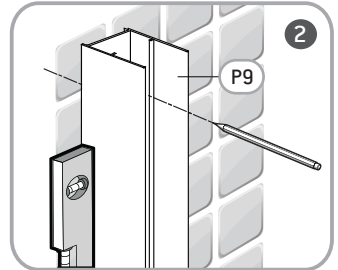
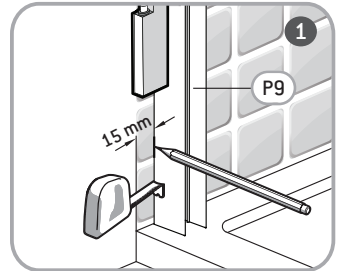
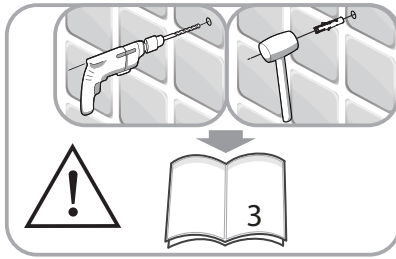

H1  x6

P9  x1





**B**

FR Montage

ES Montaje

PT Montagem

IT Montaggio

EL Συναρμολόγηση

PL Montaż

RU Сборка

UK Збірка

RO Montaj

EN Assembly

26

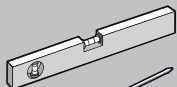
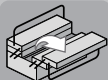
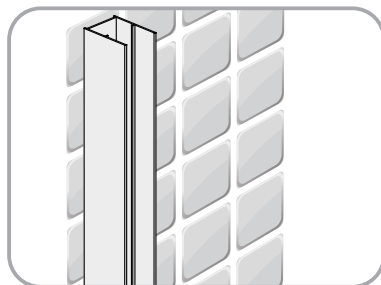
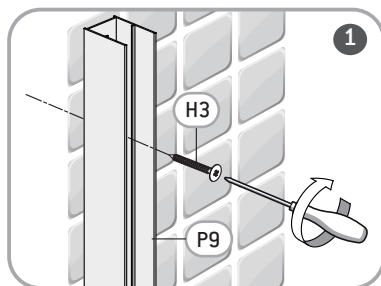
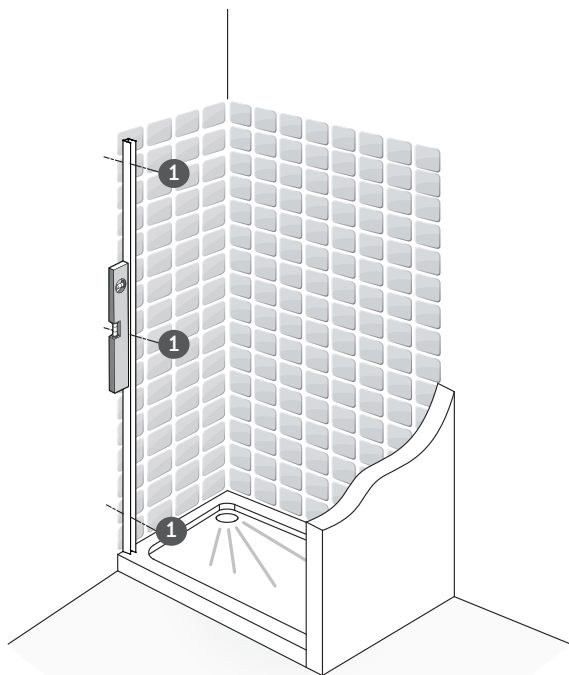
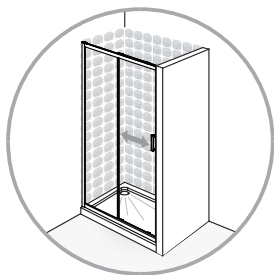

H3



x3

ST 4x40mm

P9

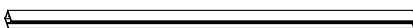

x1



FR Montage

ES Montaje

PT Montagem

IT Montaggio

EL Συναρμολόγηση

PL Montaż

RU Сборка

UK Збірка

RO Montaj

EN Assembly

B

27

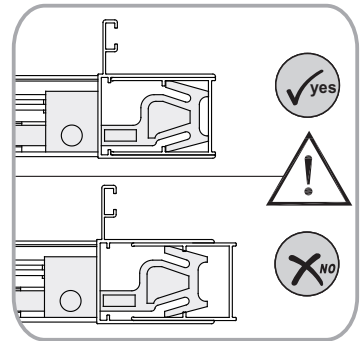
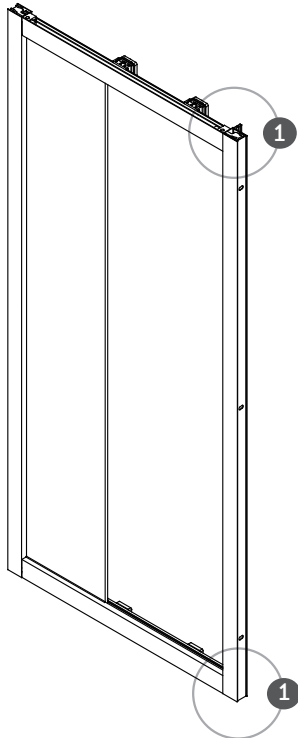
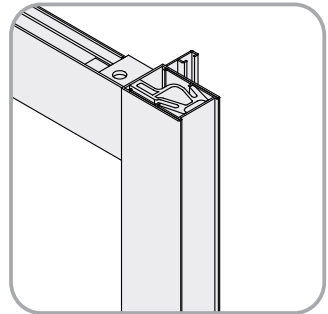
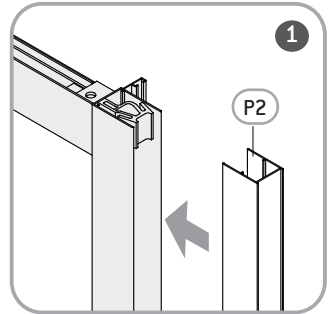
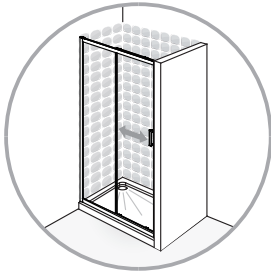

P2

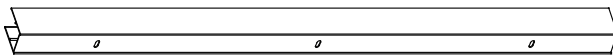

x1

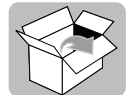

**B**

FR Montage

ES Montaje

PT Montagem

IT Montaggio

EL Συναρμολόγηση

PL Montaż

RU Сборка

UK Збірка

RO Montaj

EN Assembly

28

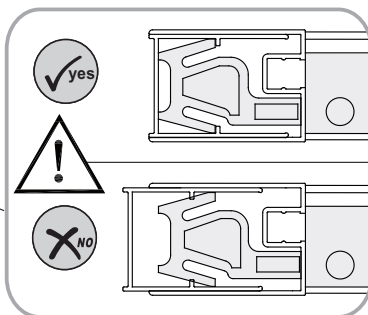
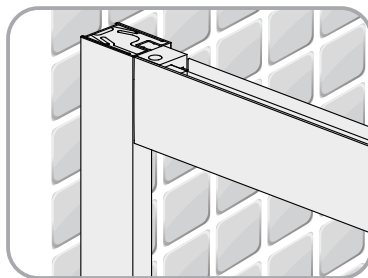
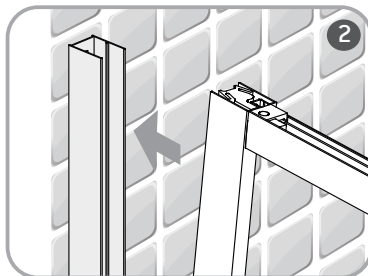
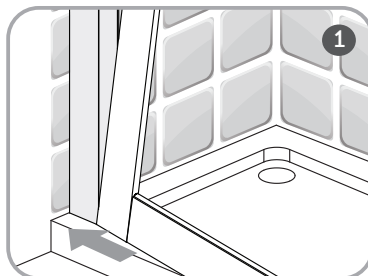
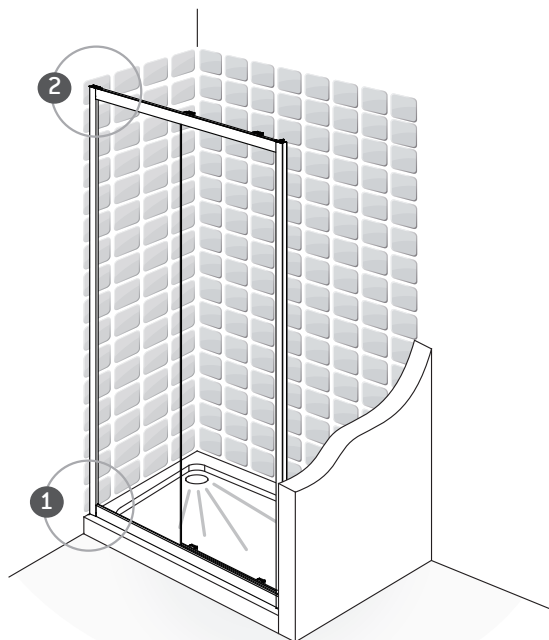
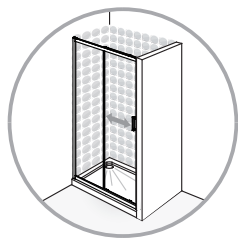
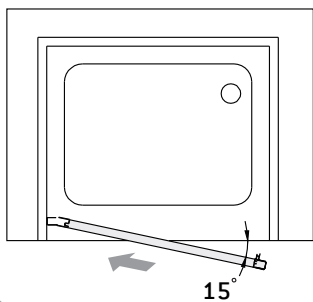

FR Montage

ES Montaje

PT Montagem

IT Montaggio

EL Συναρμολόγηση

PL Montaż

RU Сборка

UK Збірка

RO Montaj

EN Assembly

B

29

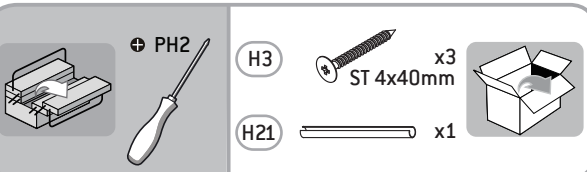
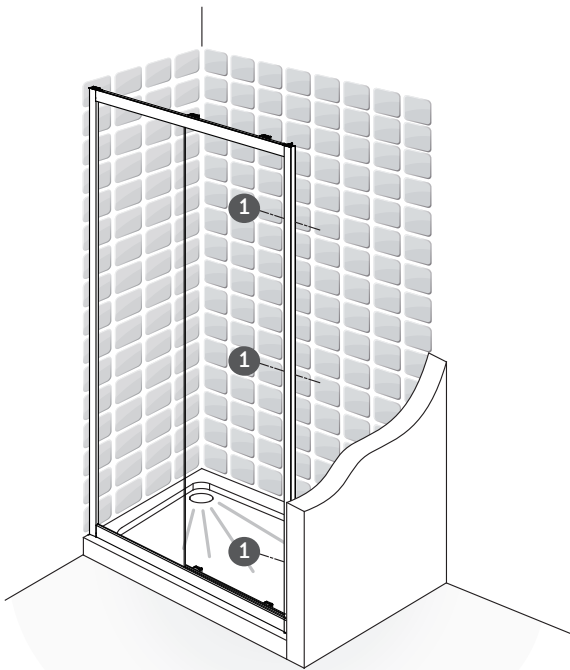
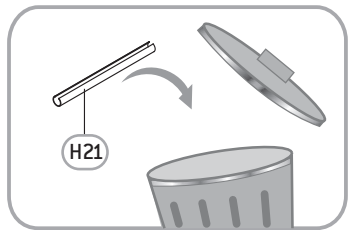
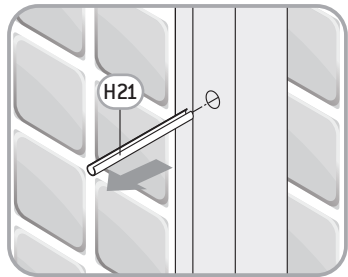
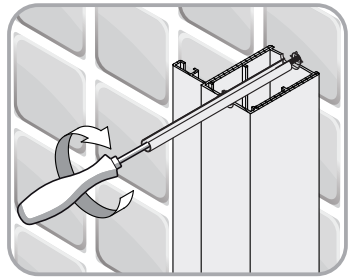
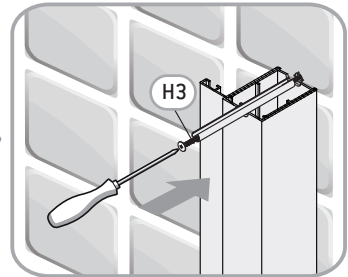
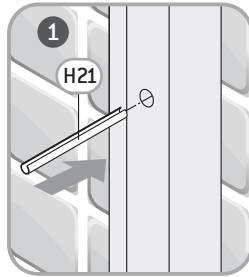
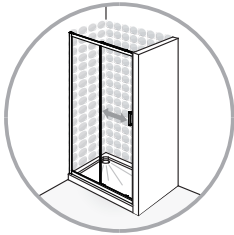

**B****FR** Montage**ES** Montaje**PT** Montagem**IT** Montaggio**EL** Συναρμολόγηση**PL** Montaż**RU** Сборка**UK** Збірка**RO** Montaj**EN** Assembly

30

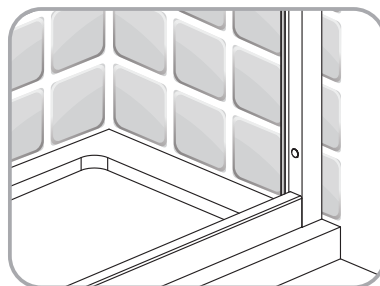
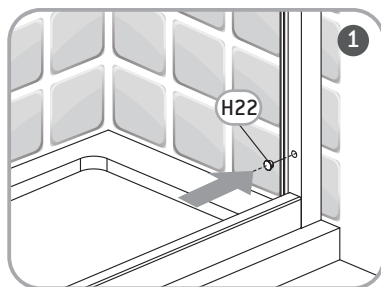
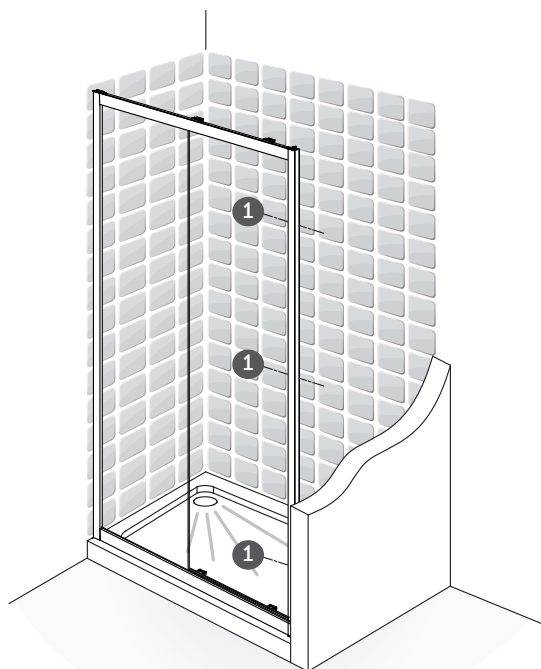
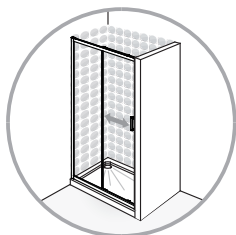

H22



x3



FR Montage

ES Montaje

PT Montagem

IT Montaggio

EL Συναρμολόγηση

PL Montaż

RU Сборка

UK Збірка

RO Montaj

EN Assembly

B

31

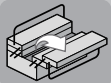
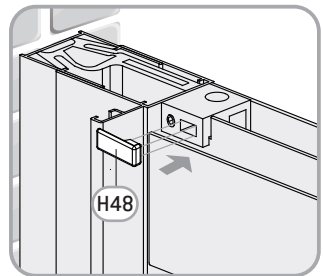
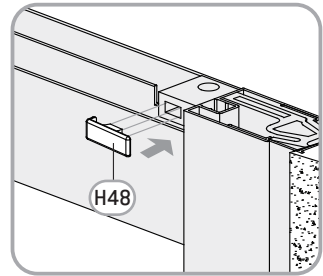
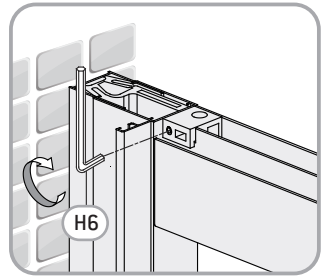
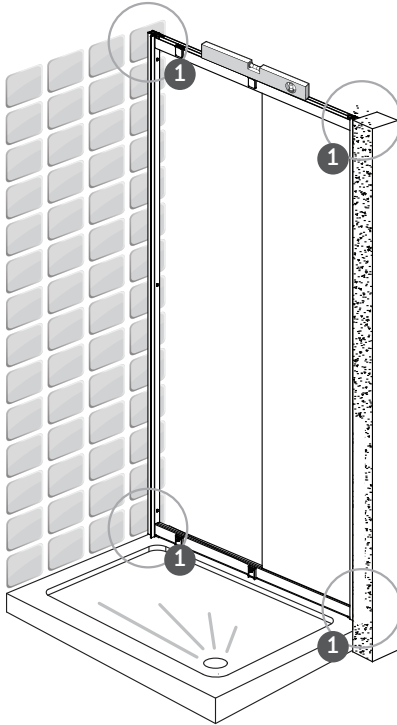
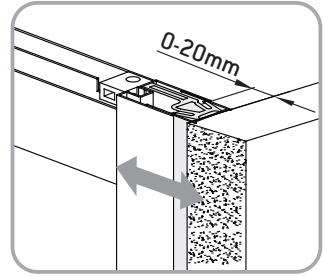
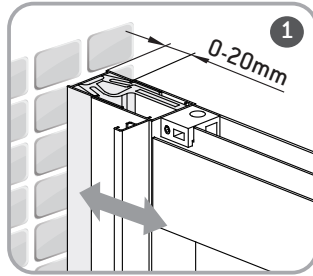
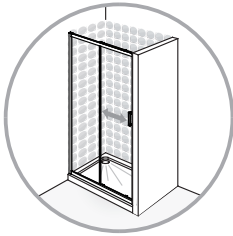

H6



x1

2mm

H48



x2



**B**

FR Montage

ES Montaje

PT Montagem

IT Montaggio

EL Συναρμολόγηση

PL Montaż

RU Сборка

UK Збірка

RO Montaj

EN Assembly

32

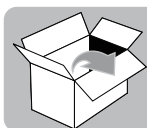
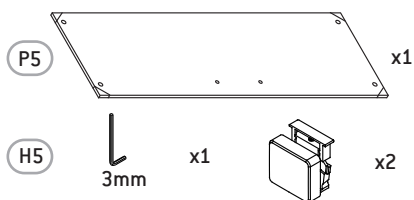
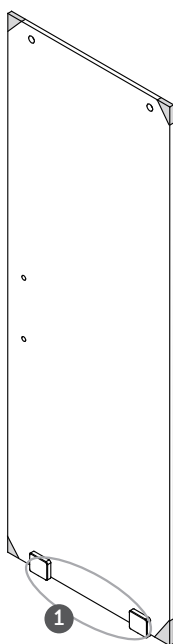
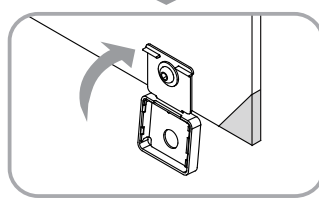
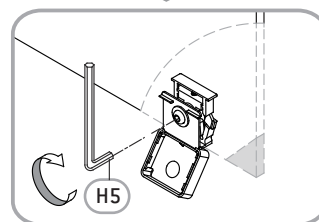
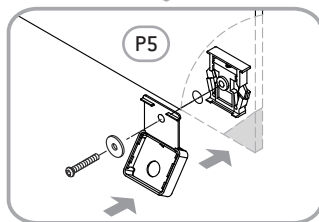
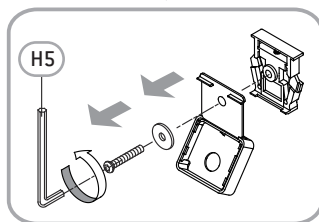
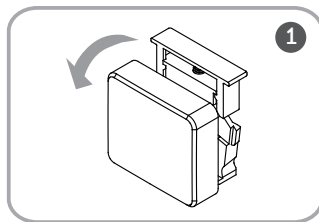
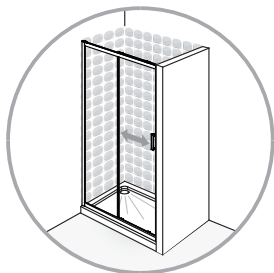

FR Montage

ES Montaje

PT Montagem

IT Montaggio

EL Συναρμολόγηση

PL Montaż

RU Сборка

UK Збірка

RO Montaj

EN Assembly

B

33

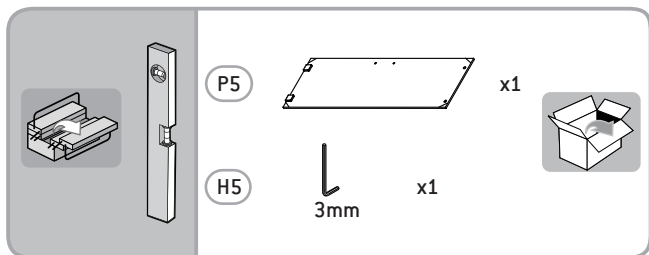
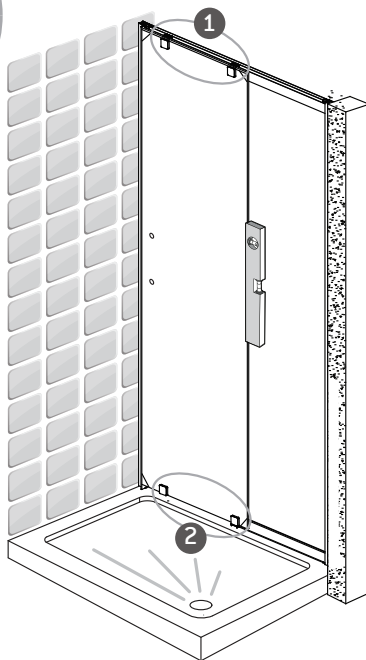
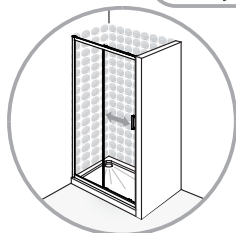
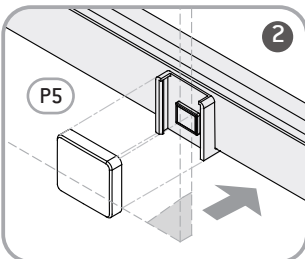
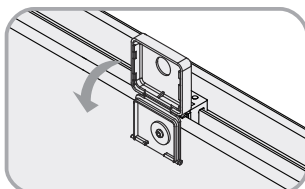
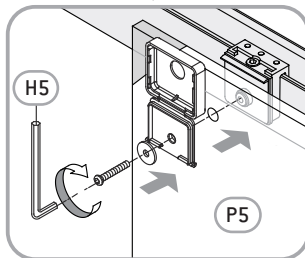
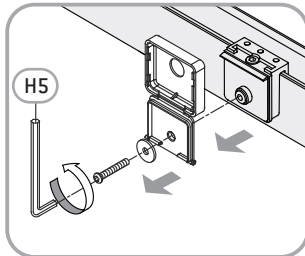
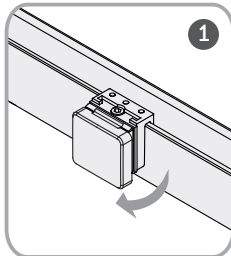



**B****FR** Montage**ES** Montaje**PT** Montagem**IT** Montaggio**EL** Συναρμολόγηση**PL** Montaż**RU** Сборка**UK** Збірка**RO** Montaj**EN** Assembly

34

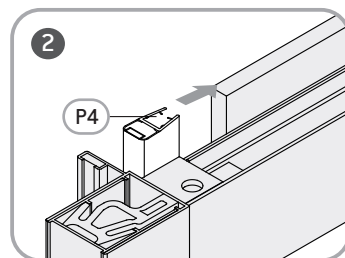
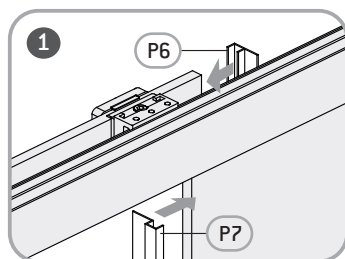
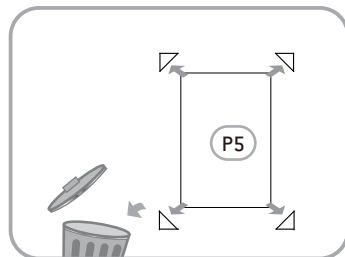
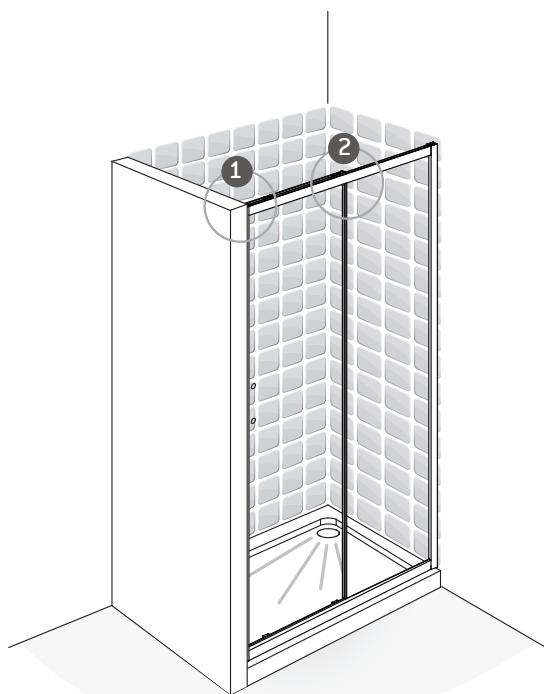

P4



x1

P6



x1

P7



x1



FR Montage

ES Montaje

PT Montagem

IT Montaggio

EL Συναρμολόγηση

PL Montaż

RU Сборка

UK Збірка

RO Montaj

EN Assembly

B

35

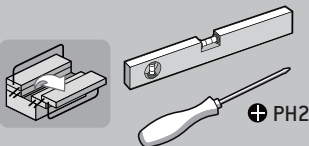
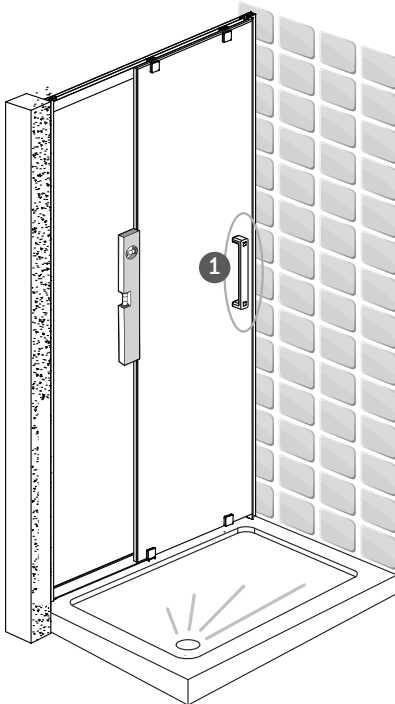
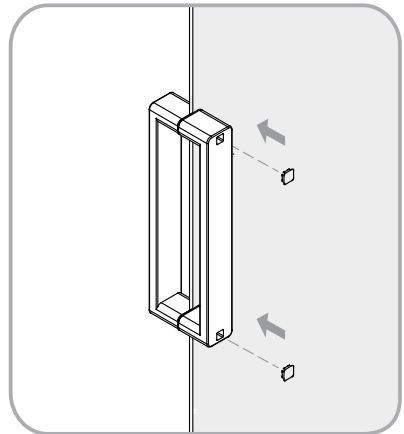
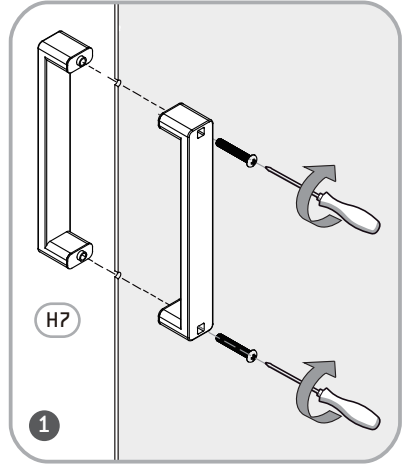
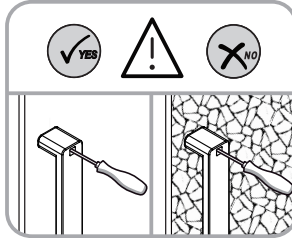
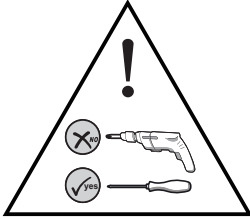

H7

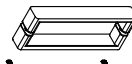

x1



**B**

FR Montage

ES Montaje

PT Montagem

IT Montaggio

EL Συναρμολόγηση

PL Montaż

RU Сборка

UK Збірка

RO Montaj

EN Assembly

36

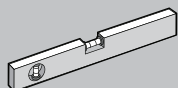
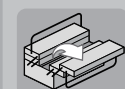
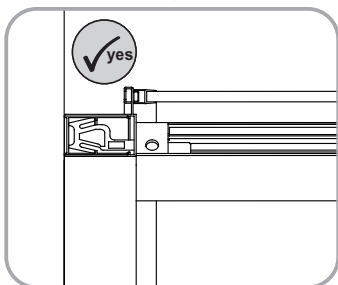
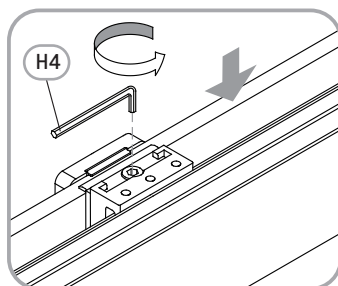
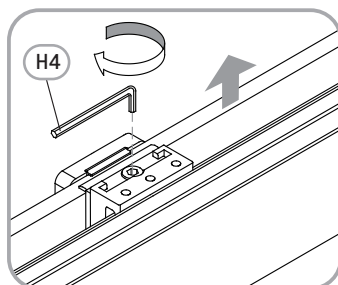
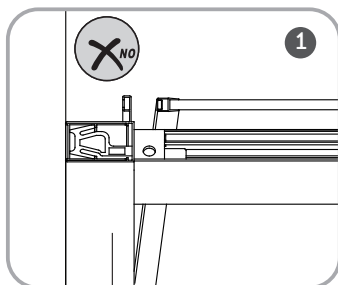

H4



x1

4mm



FR Montage

ES Montaje

PT Montagem

IT Montaggio

EL Συναρμολόγηση

PL Montaż

RU Сборка

UK Збірка

RO Montaj

EN Assembly

B

37

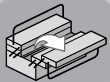
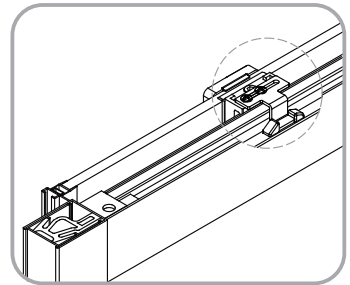
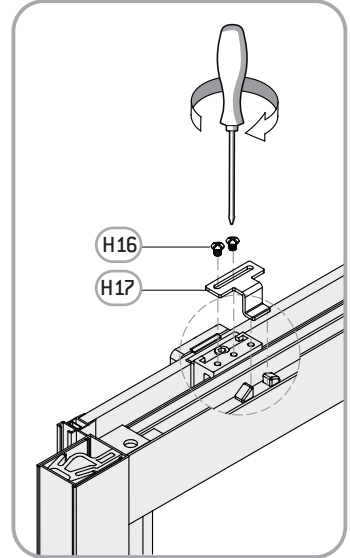
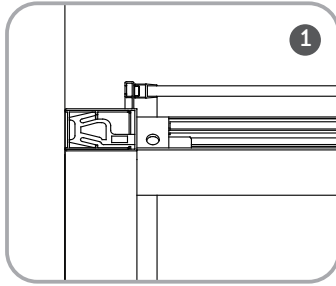

PH2

H16



x2

M 4x5mm

H17



x1



**B****FR** Montage**ES** Montaje**PT** Montagem**IT** Montaggio**EL** Συναρμολόγηση**PL** Montaż**RU** Сборка**UK** Збірка**RO** Montaj**EN** Assembly

38

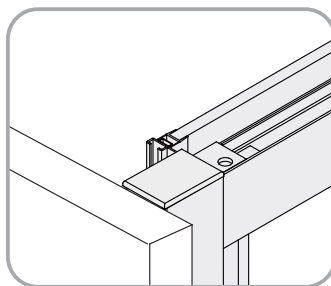
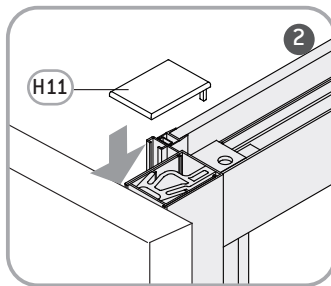
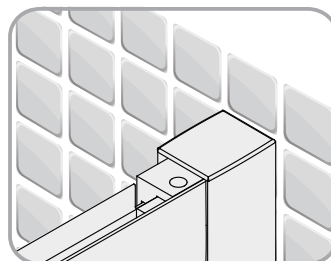
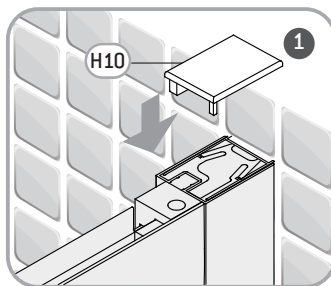
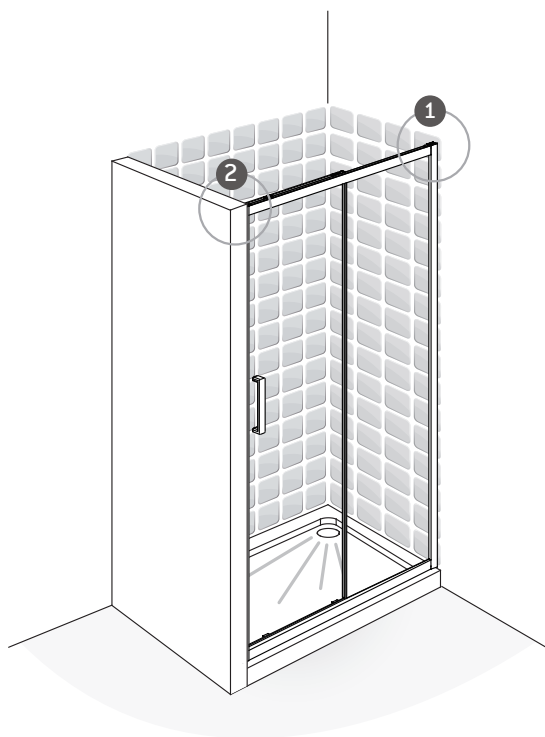

H10

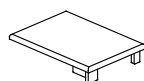

x1

H11

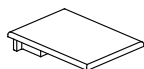

x1



FR Montage

ES Montaje

PT Montagem

IT Montaggio

EL Συναρμολόγηση

PL Montaż

RU Сборка

UK Збірка

RO Montaj

EN Assembly

B

39

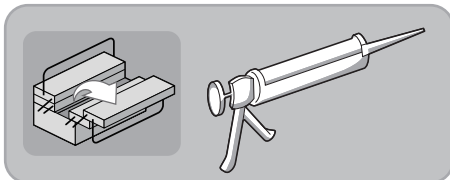
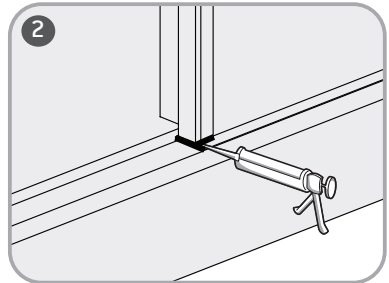
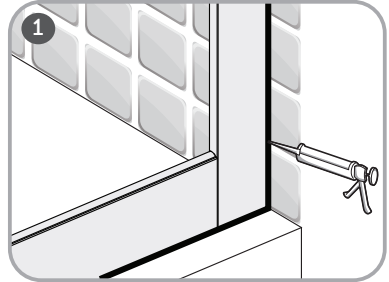
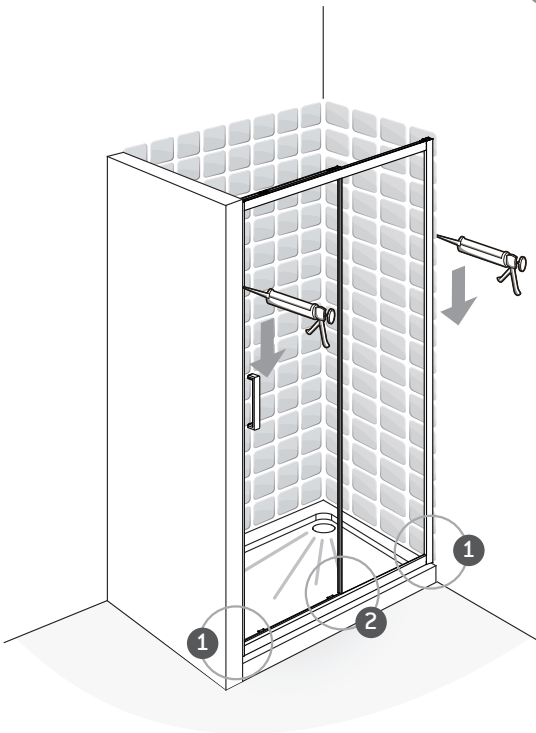
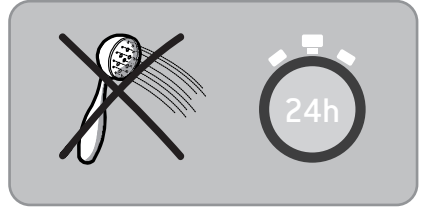

**C****FR** Entretien**ES** Mantenimiento**PT** Serviço**IT** Manutenzione**EL** Συντήρηση**PL** Konserwacja**RU** Уход**UK** Догляд**RO** Întreținere**EN** Maintenance

Sans solvant / Sin disolvente / Sem solventes / Senza solventi / Χωρίς διαλυτικά / Bez rozpuszczalnika / Без растворителя / Без розчинника / Fără solvent / Solvent-free

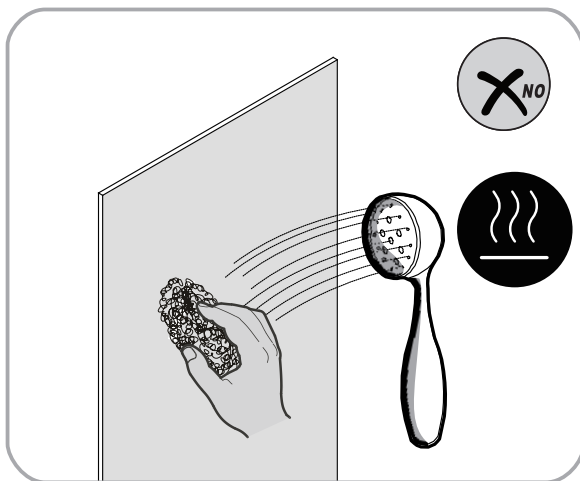
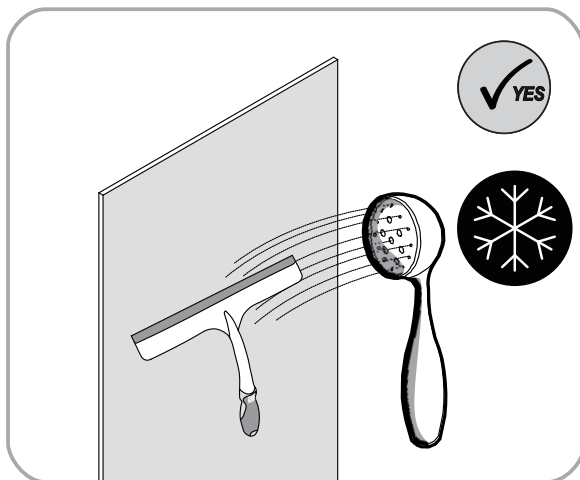

**FR**



ADEO Services - 135 Rue Sadi Carnot - CS 00001 59790 RONCHIN - France  
16  
EN 14428:2015

Code d'identification unique du produit-type: \*\*  
usage prévu: hygiène personnelle  
Nettoyable: Conforme  
Résistance à l'impact/  
Capacité de Fragmentation: Conforme  
durabilité: Conforme

DOP N ° 204003/0001/2016

**ES**



ADEO Services - 135 Rue Sadi Carnot - CS 00001 59790 RONCHIN - France  
16  
EN 14428:2015

Código de identificación única del producto tipo: \*\*  
Uso previsto: higiene personal  
Limpiable: Conforme  
Resistencia al impacto/  
Capacidad de fragmentación: Conforme  
Durabilidad: Conforme

DOP N ° 204003/0001/2016

**PT**



ADEO Services - 135 Rue Sadi Carnot - CS 00001 59790 RONCHIN - France  
16  
EN 14428:2015

Código de identificação único do produto-tipo: \*\*  
Utilização prevista: higiene pessoal  
Limpeza: Conforme  
Resistência ao impacto/  
Capacidade de fragmentação: Conforme  
Durabilidade: Conforme

DOP N ° 204003/0001/2016

**IT**



ADEO Services - 135 Rue Sadi Carnot - CS 00001 59790 RONCHIN - France  
16  
EN 14428:2015

Codice di identificazione unico del prodotto-tipo: \*\*  
Uso previsto: igiene personale  
Pulibile: Conforme  
Resistenza agli urti/  
Capacità di Frammentazione: Conforme  
Durata: Conforme

DOP N ° 204003/0001/2016

**EL**



ADEO Services - 135 Rue Sadi Carnot - CS 00001 59790 RONCHIN - France  
16  
EN 14428:2015

Μοναδικός κωδικός ταυτοποίησης του τύπου του προϊόντος: \*\*  
προβλεπόμενη χρήση: προσωπική υγιεινή  
Δυνατότητα καθαρισμού: Σύμφωνα με  
Αντοχή σε κρούση/ Ικανότητα κατάτμησης: Σύμφωνα με  
Διάρκεια: Σύμφωνα με

DOP N ° 204003/0001/2016

**PL**



ADEO Services - 135 Rue Sadi Carnot - CS 00001 59790 RONCHIN - France  
16  
EN 14428:2015

Niepowtarzalny kod identyfikacyjny typu wyrobu: \*\*  
przeznaczenie: higiena osobista  
Możliwość czyszczenia: Zgodny  
Odporność na uderzenia/  
Rozkruszalność: Zgodny  
Trwałość: Zgodny

DOP N ° 204003/0001/2016

**RU**



ADEO Services - 135 Rue Sadi Carnot - CS 00001 59790 RONCHIN - France  
16  
EN 14428:2015

Уникальный идентификационный код типа изделия: \*\*  
Назначение: личная гигиена  
Легкость очистки: Соответствие  
Ударопрочность/  
Мощность распыления: Соответствие  
Долговечность: Соответствие

DOP N ° 204003/0001/2016

**UK**



ADEO Services - 135 Rue Sadi Carnot - CS 00001 59790 RONCHIN - France  
16  
EN 14428:2015

Унікальний ідентифікаційний код виду продукції: \*\*  
призначення: особиста гігієна  
Легкість очищення: Відповідність  
Ударостійкість/  
Потужність розпилення: Відповідність  
Довговічність: Відповідність

DOP N ° 204003/0001/2016

**RO**



ADEO Services - 135 Rue Sadi Carnot - CS 00001 59790 RONCHIN - France  
16  
EN 14428:2015

Cod unic de identificare a tipului de produs: \*\*  
destinație: igienă personală  
Rezistență la impact/  
Capacitate de fragmentare: Conform  
Durabilitate: Conform

DOP N ° 204003/0001/2016

**EN**



ADEO Services - 135 Rue Sadi Carnot - CS 00001 59790 RONCHIN - France  
16  
EN 14428:2015

Unique identification code of the product-type: \*\*  
Intended use: personal hygiene  
cleanability: Pass  
Impact resistance/ shatter properties: Pass  
Durability: Pass

DOP N ° 204003/0001/2016

\*\*

**FR** Reportez-vous à l'annexe.

**ES** Consulte el apéndice.

**PT** Consulte o anexo.

**IT** Consultare l'appendice.

**EL** Ανατρέξτε στο Παράρτημα.

**PL** Patrz załącznik.

**RU** См. приложение.

**UK** Читайте додаток.

**RO** Consultați anexa.

**EN** Refer to appendix.



ADEO Services  
135 Rue Sadi Carnot  
CS 00001  
59790 RONCHIN - France

ТОВ «Леруа Мерлен Україна»,  
вул. Полярна 17а, м. Київ  
04201, Україна

ООО ЛЕРУА МЕРЛЕН ВОСТОК,  
141031, Московская область,  
Мытищинский район, г. Мытищи,  
Осташковское шоссе, д.1, РОССИЯ

\* Garantie 5 ans / Garantía 5 años / Garantia 5 anos / Garanzia 5 anni  
Εγγύηση 5 ετών / Gwarancja 5 lat / 5 летняя / 5-річна гарантія  
5 ani garanție / Guarantee 5 years

Made In P. R.C. 2016